

Serial↔WLAN Board

# CSW-B85 User Manual

Version 2.3



Sollae Systems Co., Ltd.

<http://www.ezTCP.com>



This symbol, found on your product or on its packaging, indicates that this product should not be treated as household waste when you wish to dispose of it. Instead, it should be handed over to an applicable collection point for the recycling of electrical and electronic equipment. By ensuring this product is disposed of correctly, you will help prevent potential negative consequences to the environment and human health, which could otherwise be caused by inappropriate disposal of this product. The recycling of materials will help to conserve natural resources. For more detailed information about the recycling of this product, please contact your local city office, household waste disposal service or the retail store where you purchased this product.

※ This equipment obtained certification by using 1.5M serial cable.

※ L'antenne de ce boîtier devra être placée à une distance minimale de 2 m de toute personne et animal.

# Contents

<b>1</b>	<b>Overview .....</b>	<b>- 5 -</b>
1.1	Overview .....	- 5 -
1.2	Features .....	- 5 -
1.3	Application Examples .....	- 6 -
1.4	Components.....	- 7 -
1.5	Specification .....	- 7 -
1.5.1	Hardware .....	- 7 -
1.5.2	Software .....	- 7 -
1.5.3	Dimension .....	- 8 -
1.6	Interface .....	- 9 -
1.6.1	Serial Port Parameters .....	- 9 -
1.6.2	Port Assignment.....	- 9 -
<b>2</b>	<b>Installation and Test.....</b>	<b>- 12 -</b>
2.1	Wireless LAN Overview.....	- 12 -
2.1.1	WLAN mode: Infrastructure.....	- 12 -
2.1.2	WLAN mode: Ad-hoc .....	- 13 -
2.1.3	WLAN mode: Soft AP.....	- 14 -
2.1.4	Key terms.....	- 15 -
2.1.5	Authentication and Security.....	- 15 -
2.2	Installation.....	- 16 -
2.2.1	Making Wireless LAN link .....	- 16 -
2.2.2	Setting Network Area .....	- 19 -
2.3	Simple Test.....	- 21 -
<b>3</b>	<b>Configuration .....</b>	<b>- 24 -</b>
3.1	Configuration with ezManager.....	- 24 -
3.1.1	Configuration via Serial .....	- 24 -
3.1.2	Configuration via WLAN .....	- 25 -
3.2	AT command.....	- 26 -
3.3	WEB Configuration.....	- 27 -
<b>4</b>	<b>Operation Modes .....</b>	<b>- 29 -</b>
4.1	What is the Operation Mode?.....	- 29 -
4.2	Changing modes.....	- 29 -
4.3	Comparison with each mode .....	- 30 -
4.4	Normal Mode .....	- 30 -

4.4.1	WLAN mode .....	- 30 -
4.4.2	Communication mode.....	- 31 -
4.5	Serial Configuration Mode .....	- 32 -
4.5.1	Configuring Parameters.....	- 32 -
4.5.2	Revoking Security Options.....	- 32 -
4.5.3	Background Soft AP function .....	- 32 -
4.6	ISP Mode .....	- 32 -
4.6.1	Upgrading Firmware.....	- 32 -
<b>5</b>	<b>Communication Modes .....</b>	<b>- 33 -</b>
5.1	TCP Server .....	- 33 -
5.1.1	Key parameters.....	- 33 -
5.1.2	Examples .....	- 34 -
5.2	TCP Client .....	- 37 -
5.2.1	Key parameters.....	- 37 -
5.2.2	Examples .....	- 38 -
5.3	AT Command .....	- 41 -
5.3.1	Key parameters.....	- 41 -
5.3.2	Examples .....	- 42 -
5.4	UDP .....	- 45 -
5.4.1	Key parameters.....	- 45 -
5.4.2	Examples .....	- 46 -
<b>6</b>	<b>System Management.....</b>	<b>- 48 -</b>
6.1	Upgrading Firmware.....	- 48 -
6.1.1	Firmware .....	- 48 -
6.1.2	Processes .....	- 48 -
6.2	Status Monitoring.....	- 50 -
6.2.1	TELNET .....	- 50 -
6.2.2	Status Window of ezManager .....	- 52 -
<b>7</b>	<b>Additional Functions.....</b>	<b>- 56 -</b>
7.1	Security .....	- 56 -
7.1.1	Access Restriction (ezTCP Firewall).....	- 56 -
7.1.2	Setting Password.....	- 56 -
7.1.3	Using WEP .....	- 57 -
7.1.4	Using WPA-PSK .....	- 57 -
7.1.5	Using WPA-Enterprise.....	- 58 -
7.1.6	Advanced Settings .....	- 59 -
7.2	Option Tab Functions.....	- 60 -

7.2.1	Notify IPv4 Change.....	- 60 -
7.2.2	Sending MAC Address .....	- 61 -
7.3	Serial Port Tab Functions.....	- 62 -
7.3.1	TELNET COM port Control Option (RFC 2217) - ①.....	- 62 -
7.3.2	Disable TCP Transmission Delay - ② .....	- 62 -
7.3.3	Data Frame Interval - ③ .....	- 63 -
7.3.4	Separator - ④.....	- 63 -
7.3.5	TCP Server / Client mode - ⑤ .....	- 63 -
7.4	Additional Functions.....	- 64 -
7.4.1	Wireless RSSI(Received Signal Strength Indication) function .....	- 64 -
7.4.2	Factory Reset .....	- 65 -
<b>8</b>	<b>Checklist in Trouble.....</b>	<b>- 66 -</b>
8.1	Searching problem with ezManager.....	- 66 -
8.2	Connection Problem over TCP/IP.....	- 67 -
8.3	Data Communication Problem on the Serial Port .....	- 68 -
<b>9</b>	<b>Related Materials.....</b>	<b>- 69 -</b>
9.1	Documents.....	- 69 -
9.2	Applications for a Smart Phone.....	- 69 -
<b>10</b>	<b>Technical Support and Warranty.....</b>	<b>- 70 -</b>
10.1	Technical Support .....	- 70 -
10.2	Warranty.....	- 70 -
10.2.1	Refund.....	- 70 -
10.2.2	Free Repair Services .....	- 70 -
10.2.3	Charged Repair Services.....	- 70 -
<b>11</b>	<b>Precaution and Exemption from Liability .....</b>	<b>- 71 -</b>
11.1	Precaution.....	- 71 -
11.2	Exemption from Liability.....	- 72 -
11.2.1	English version .....	- 72 -
11.2.2	French version .....	- 73 -
<b>12</b>	<b>Revision History.....</b>	<b>- 75 -</b>

# 1 Overview

## 1.1 Overview

Almost all communication devices including a PC are using serial communication. Devices transmit and receive data in bit order in the serial communication which is quite simple to implement but has weaknesses such as short distance and hard maintenance.

CSW-B85 is a board-typed converter, which embeds CSW-M85 module, enables serial devices to support TCP/IP communication through wireless LAN (IEEE 802.11b/g). CSW-B85 carries out the converting process for users to get to the network using TCP/IP protocol.

## 1.2 Features

- Board type for CSW-M85: easy to use
- Connect serial devices to IEEE 802.11b/g wireless LAN
- LVTTTL/RS232/RS422/RS485 interface
- IPv4/IPv6 Dual Stack
- Soft AP mode: support WEP and simple DHCP server
- Various WLAN securities: WPA-PSK, WPA-Enterprise(EAP-TLS/TTLS, PEAP)
- Wireless RSSI(Wireless Signal Strength Indication) mode
- Both Internal (Chip) and External (U.FL socket) antennas are available.
- Stable embedded TCP/IP stack
- Easy configuration program (ezManager / web configuration)

### 1.3 Application Examples

- 1:1 network with a PC

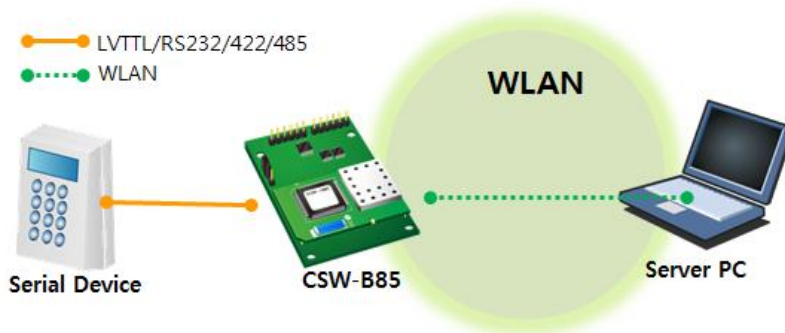

Figure 1-1 1:1 network with a PC

- 1:1 network with a PC through an AP

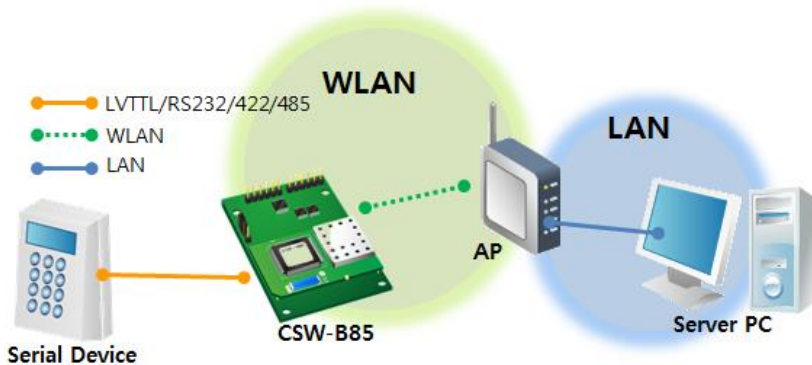

Figure 1-2 1:1 network with a PC through an AP

- Internet connection with a xDSL/cable modem

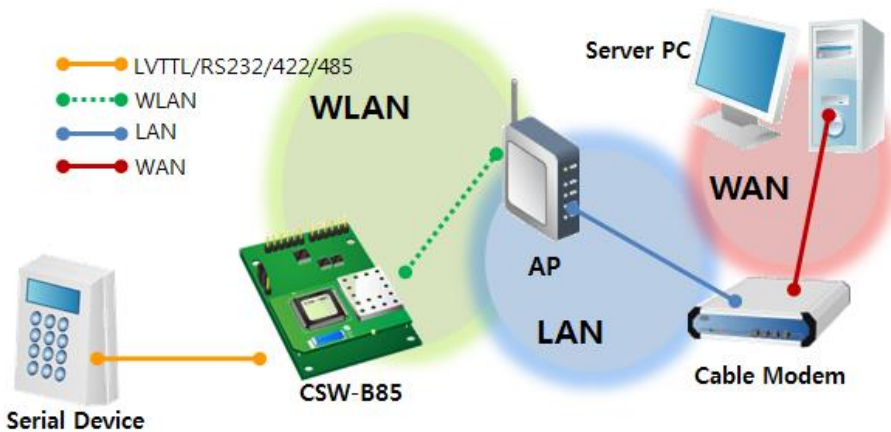

Figure 1-3 Internet connection with an xDSL/cable modem

## 1.4 Components

- CSW-B85's body
- U.FL-SMA cable (Optional)
- DVD including utilities and documents (Optional)

## 1.5 Specification

### 1.5.1 Hardware

Power	Input Voltage	DC 5V ( $\pm 0.5V$ )
	Current	Typically 260mA
Dimension	60mm x 42mm	
Weight	About 18g	
Serial Port	Serial	1 x UART – LVTTTL / RS232 / RS422 / RS485 (Baud Rate: 300bps ~ 230,400bps)
	WLAN	Chip Antenna / U.FL connector(Selectable) (IEEE 802.11b/g)
Temperature	Operating: $-10 \sim 70^{\circ}C$ / Storage: $-40 \sim 85^{\circ}C$	
RoHS	RoHS Compliant	

Table 1-1 hardware specification

### 1.5.2 Software

Protocol	IPv4/IPv6 Dual stack, TCP, UDP, IP, ICMP, ARP, TELNET, DHCP, DNS lookup, DDNS, Telnet COM Port Control Option(RFC2217), WEP, WPA-PSK, WPA-Enterprise (EAP-TLS/TTLS, PEAP)	
Operation mode	Normal	For Normal Data Communication
	ISP	For Upgrading F/W
	Serial Configuration	For Configuration via Serial
Communication mode	TCP Server	TCP Passive Connection
	TCP Client	TCP Active Connection
	AT Command	TCP Passive / Active Connection
	UDP	UDP
Major Utilities	ezManager	Configuration Utility for MS Windows
	ezVSP	Serial to TCP/IP Virtual driver for MS Windows

Table 1-2 software specification



### 1.5.3 Dimension

- Top view

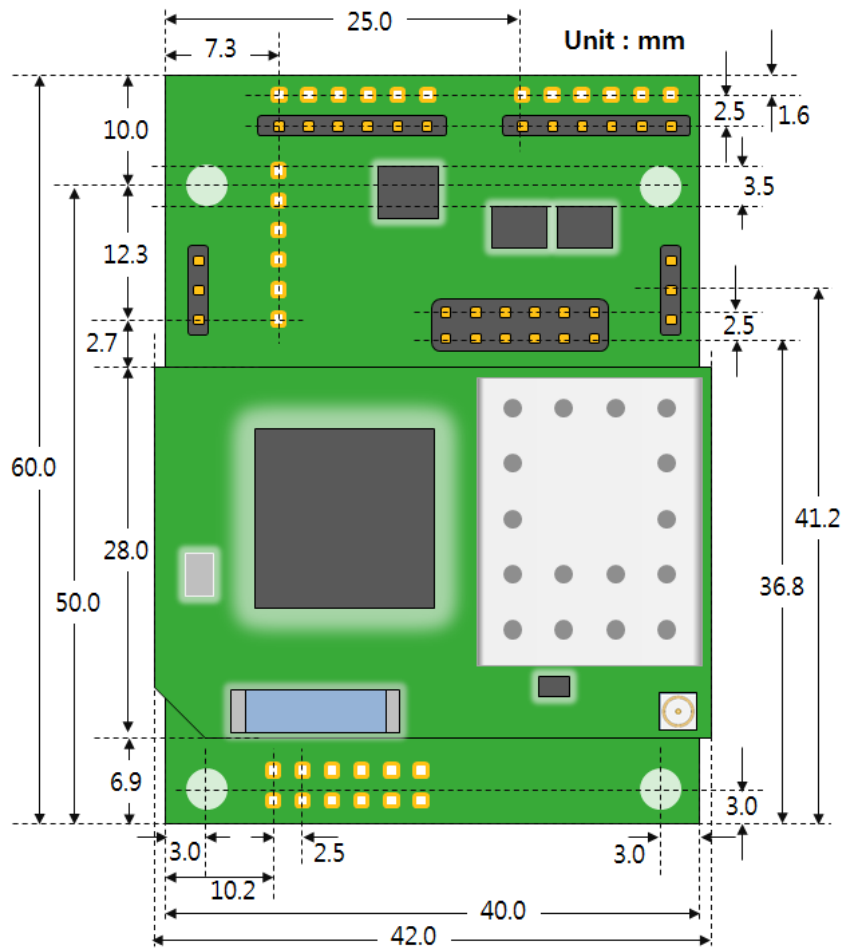

Figure 1-4 top view

- Side view

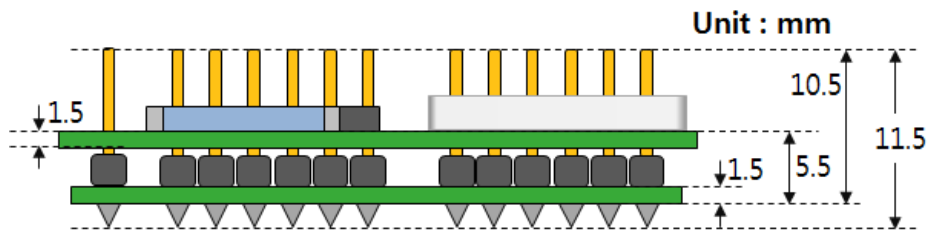

Figure 1-5 Side view

☞ According to conditions of soldering components, the dimensions might be differed with the above figure.

## 1.6 Interface

### 1.6.1 Serial Port Parameters

Parameter	Value
Number	1
Type	LVTTTL / RS232 / RS422 / RS485
Baud rate	300 ~ 230,400 [bps]
Parity	NONE / EVEN / ODD / MARK / SPACE
Data bit	8 / 7 / 6 / 5
Stop bit	1 / 2
Flow control	NONE / RTS/CTS

Table 1-3 serial port parameters

**Note that the duration of [Stop bit] will be not 2 bits but 1.5 bits, if you set [Data bit] to 5.**

### 1.6.2 Port Assignment

- P3

P3 is for serial interfaces.

Interface	Jumper Position	Interface	Jumper Position
RS232		RS422	
LVTTTL		RS485	

Table 1-4 jumper positions for serial interfaces

- P1 and P2

P1 and P2 are for RS232 communication.

P1/P2	Name	Description	Type
1	5V	DC 5V IN	IN
2	RXD	RS232 RXD	IN
3	TXD	RS232 TXD	OUT
4	GND	Ground	-
5	RTS	RS232 RTS	OUT
6	CTS	RS232 CTS	IN

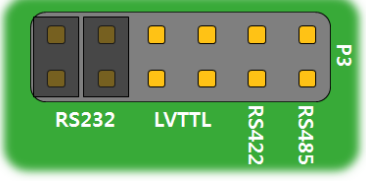
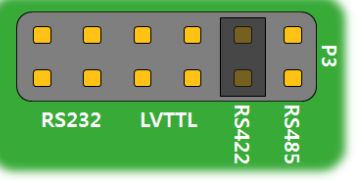
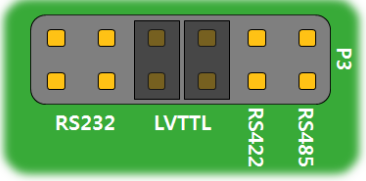
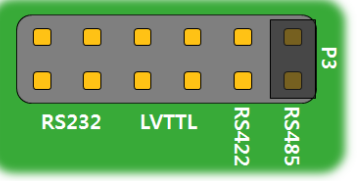
Table 1-5 pin assignment of P1 and P2

- P4 and P5

P4 and P5 are for RS422 or RS485 communication.

P4/P5	Name	Description	Type
1	5V	DC 5V IN	IN
2	TRX+ (TX+)	TRX+ (RX485) / TX+ (RS422)	IN/OUT
3	TRX- (TX-)	TRX- (RS485) / TX- (RS422)	IN/OUT
4	GND	Ground	-
5	RX+	RS232 RTS (RS422 only)	IN
6	RX-	RS232 CTS (RS422 only)	IN

Table 1-6 pin assignment of P4 and P5

- P6

P6 is for LVTTTL communication.

P6	Name	Description	Type
1	5V	DC 5V POWER	IN
2	RXD	TTL RXD	IN
3	TXD	TTL TXD	OUT
4	GND	Ground	-
5	RTS	TTL RTS	OUT
6	CTS	TTL CTS	IN

Table 1-7 pin assignment of P6

- P10

P10 is for LED interfaces.

- J1

J1 is for switching operation modes.

J1	Serial Configuration mode	Normal mode
Jumper position	 <p>Nota that you should remove the jumper within 1 sec after put it on "ISP" position.</p>	

Table 1-8 use of J1

- J2

J2 is for switching operation mode and Wireless RSSI function.

J2	Normal mode (Wireless RSSI function ON)	Serial Configuration mode
Jumper position		

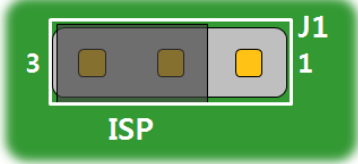
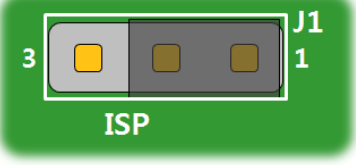
Table 1-9 use of J2

- LED indicators

Name	Color	Description
LD1	Green	Normal mode: the same with STS LED
		ISP mode: blinks in every second
PWR	Red	ON while power is supplied
STS	Green	ON while TCP connection is established
		blinking every second obtaining an IP address
		blinking four times at once
LINK	Green	ON while a wireless LAN is established
RXD	Green	blinking when receiving data from a network
TXD	Green	blinking when transmitting data to a network
TCP	Green	ON while TCP connection is established

Table 1-10 LED indicators

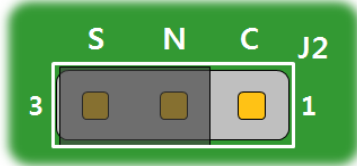
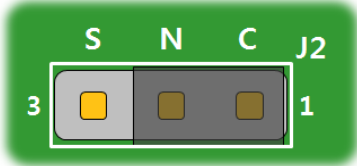
☞ **Please refer to the chapter 7.4.1, if you want to know operation of indicators in the case of using Wireless RSSI function.**

## 2 Installation and Test

### 2.1 Wireless LAN Overview

CSW-B85 supports IEEE802.11b/g called wireless LAN briefly. It has two network topologies and those are Infrastructure and Ad-hoc mode.

#### 2.1.1 WLAN mode: Infrastructure

In this mode, every wireless LAN station communicates through an Access Point (AP), which is able to interface with both wireless LAN and Ethernet, so that all stations can be connected to Ethernet.

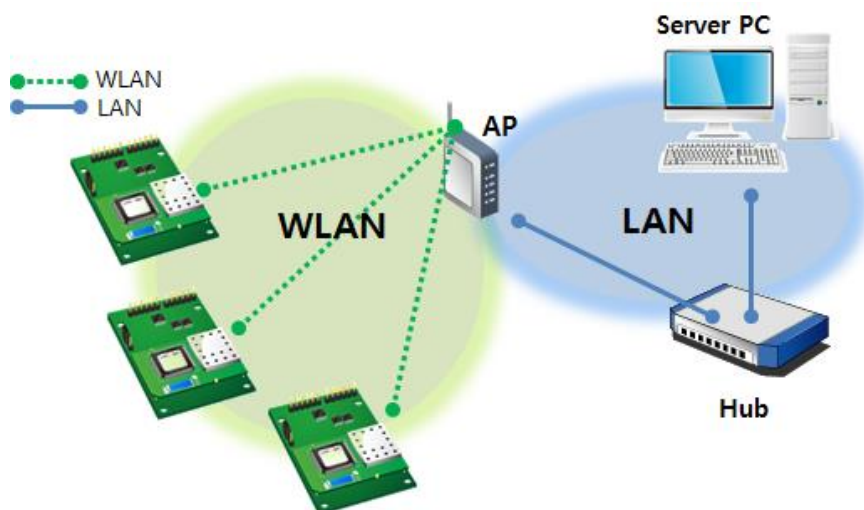

Figure 2-1 infrastructure mode

Select [Infrastructure] on [Wireless LAN] tab of ezManager.

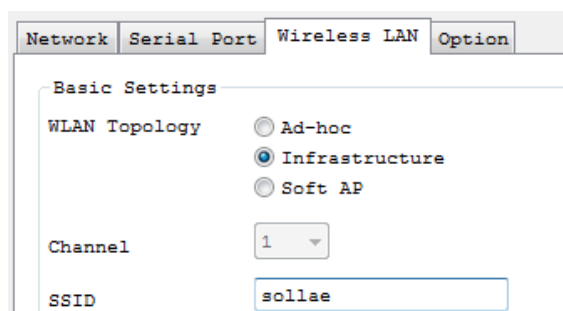

Figure 2-2 setting of Infrastructure

*You can download ezManager on our website.*

### 2.1.2 WLAN mode: Ad-hoc

This is an easy way to set up network since wireless LAN stations communicate each other without an AP in this mode. Therefore, you can easily make this network. It is suitable for a small scale network if wired LAN is not available. Usually, it is called peer-to-peer mode.

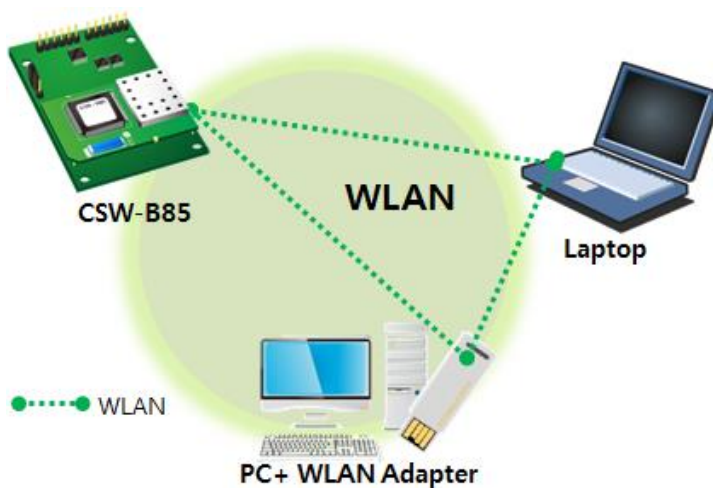

Figure 2-3 Ad-hoc mode

Select [Ad-hoc] on [Wireless LAN] tab of ezManager.

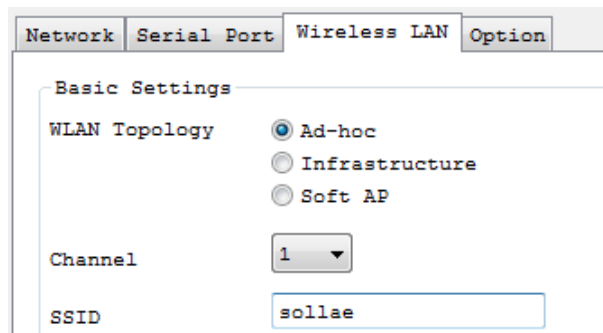

Figure 2-4 setting of Ad-hoc

### 2.1.3 WLAN mode: Soft AP

Soft AP (Software embedded Access Point) is a mode that a wireless client can act as an AP through software embedded AP functions. Using this mode, the wireless client allows you to communicate with not only laptops and smartphones but also devices without Ad-hoc function.

CSW-B85 supports Soft AP function. While operating in this function, it has an IP address of 10.1.0.1 and assigns one of 10.1.X.X IP addresses to each wireless client. (A simple DHCP server)

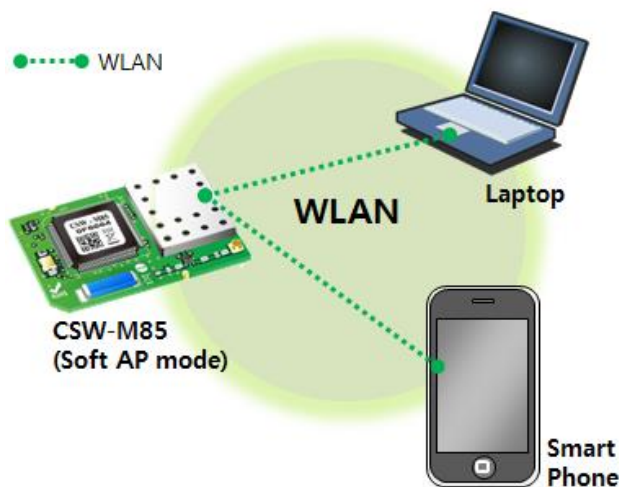

Figure 2-5 Soft AP mode

Although this function is automatically operated in Serial Configuration mode, you can set this function manually on [Wireless LAN] tab of ezManager like the figure below.

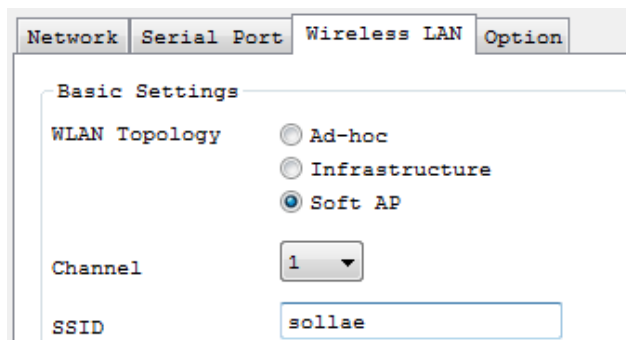

Figure 2-6 setting of Soft AP

*☞ You can download ezManager application for a smart phone on our website.*

#### 2.1.4 Key terms

- SSID (Service Set Identifier)

It is a name to identify wireless LAN. So every single station should have the same SSID to communicate in the network. In the case of infrastructure mode, you have to set the same SSID at an AP to CSW-B85. Otherwise, it will not communicate at all. The maximum length of this parameter is 31 bytes and the default is "sollae".

- Channel

Wireless LAN stations communicate through the ISM (Industrial, Scientific, and Medical) band which has the range of frequencies around 2.4GHz or 5GHz. IEEE 802.11 specification divides this band into 14 channels. If you install more than one wireless network in the same area, the channels should have intervals more than 4 channels between each other to avoid interferences.

#### 2.1.5 Authentication and Security

- Authentication

A wireless LAN station should get authentication from the AP in the infrastructure network. There are two methods for the authentication and those are: Open system and the Shared key.

- WEP (Wired Equivalent Privacy)

The WEP is a security protocol for wireless LAN. You need to set 64 bit or 128 bit key. You can use both hexadecimal and ASCII code for this.

- WPA (Wi-Fi Protected Access)

WPA is a security standard for users of devices equipped with wireless connection. It has been improved to replace the weakness of the original wireless security standard, Wired Equivalent Privacy (WEP). There are two modes about the user authentication in WPA security. One is Enterprise which has an authentication server and the other is PSK (Pre-Shared Key) which does not have any servers.

- WPA2

For final security of Wireless LAN, The Counter Mode with Cipher Block Changing Message Authentication Code Protocol (CCMP) was suggested for IEEE80211i (Wireless LAN standard) to replace the TKIP. CCMP uses Advanced Encryption Standard (AES) which is adopted by WPA2. WPA 2 has also both Enterprise and PSK mode.



## 2.2 Installation

Before testing CSW-B85, make sure that a connection between your PC and CSW-B85 is established via Serial and wireless LAN. When you connect RS232 port of your PC to CSW-B85, you should connect TX, RX and GND pin on P1 (or P2) port with cross over cable. This section is an example which is based on Infrastructure mode.

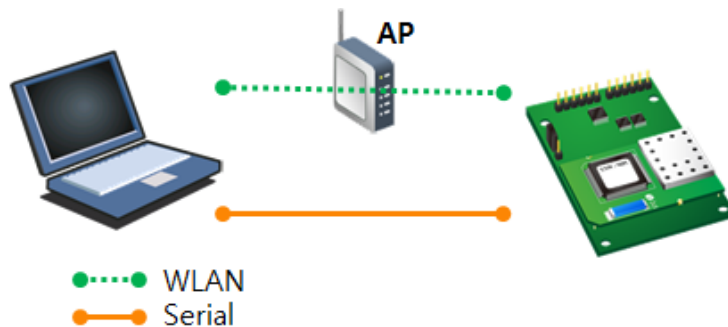

Figure 2-7 WLAN and RS232 connection using a laptop

### 2.2.1 Making Wireless LAN link

When you connect an AP or wireless LAN adapter to your PC, Wireless LAN link is not automatically established. Therefore, its parameters should be set on CSW-B85 beforehand.

- Setting by Serial

- ① Supplying Power

Supply power to the board.

- ② Change the mode to [Serial Configuration mode]

Change the operation mode to Serial Configuration mode.

☞ ***Please refer to the table 1-8 or 1-9 to switch the operation mode from normal mode to serial configuration mode.***

- ③ Reading environmental parameters

Run ezManager and open the COM port. And then, press the [Read] button.

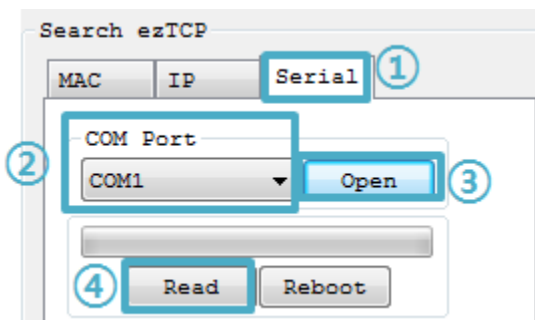

Figure 2-8 reading environmental parameters

## ④ Configuring Wireless LAN Parameters

On the [Wireless LAN] tab, set the same SSID and security options properly for the AP.

The screenshot displays the configuration interface for the Wireless LAN tab. At the top, there are four tabs: 'Network', 'Serial Port', 'Wireless LAN', and 'Option'. The 'Wireless LAN' tab is selected. Below the tabs, there are two main sections: 'Basic Settings' and 'Security Settings'.

**Basic Settings:**

- WLAN Topology:** Three radio buttons are present: 'Ad-hoc' (unselected), 'Infrastructure' (selected), and 'Soft AP' (unselected).
- Channel:** A dropdown menu is set to '1'.
- SSID:** A text input field contains the value 'sollae'.
- Antenna:** Two radio buttons are present: 'Internal Antenna' (selected) and 'External Antenna' (unselected).
- Below these options is a button labeled 'Advanced Settings'.

**Security Settings:**

- Shared Key:** A text input field is empty.
- Hide Characters:** A checkbox is checked.
- 802.1X:** A dropdown menu is set to 'Disable'.
- Below these options is a button labeled 'ID/Password'.

Figure 2-9 an example for setting WLAN parameters

- Setting by Soft AP

In case that you cannot use serial port, Soft AP function allow you to set those parameters as follows;

- ① Supplying Power
- ② Entering Serial Configuration mode

Soft AP is automatically activated when products are under Serial Configuration mode.

③ Connecting to WLAN using Soft AP

Connect laptop or smartphone to WLAN network made by product's Soft AP function. The SSID is "cfg\_MAC Address". (e.g. cfg\_0030f9000001)



Figure 2-10 Connecting to WLAN using Soft AP

④ Connecting to Web Configuration Page

Run a web browser and connect to 10.1.0.1. Set proper WLAN parameters on the page.

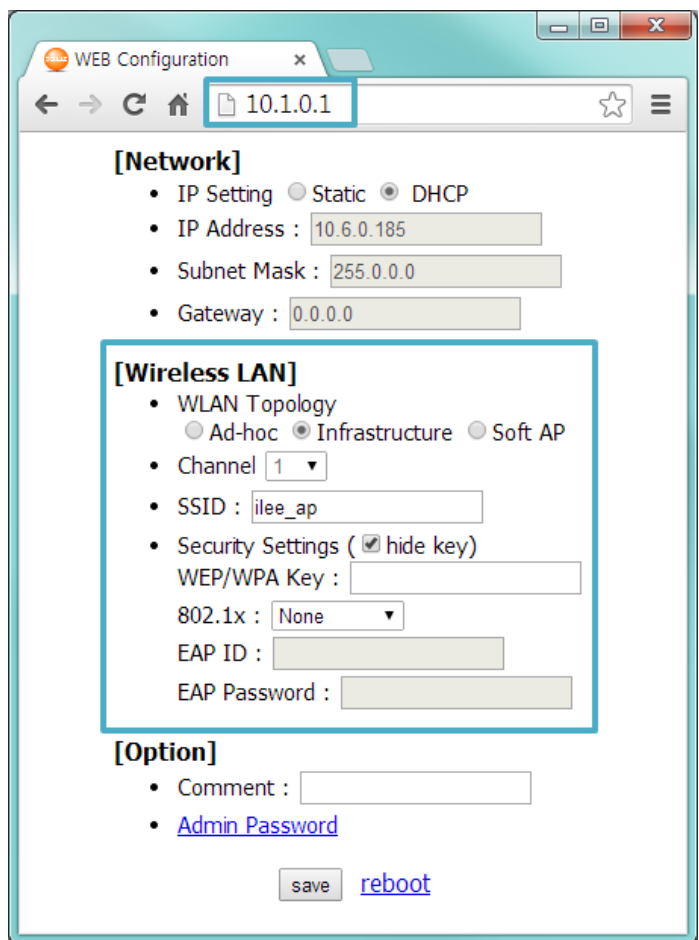

Figure 2-11 Connecting to Web Configuration Page

## 2.2.2 Setting Network Area

This procedure should be followed to make CSW-B85 and your PC located on the same network for a TCP connection.

- PC settings

Add or change the IP address of the network adapter on your PC as follows.

Click [Windows Control Panel] >> [Network Connections] and [Properties of the Network Adapter]. Then, you can see the properties of [Internet Protocol (TCP/IP)].

Press the [Advanced] button and add an IP Address like the figure below.

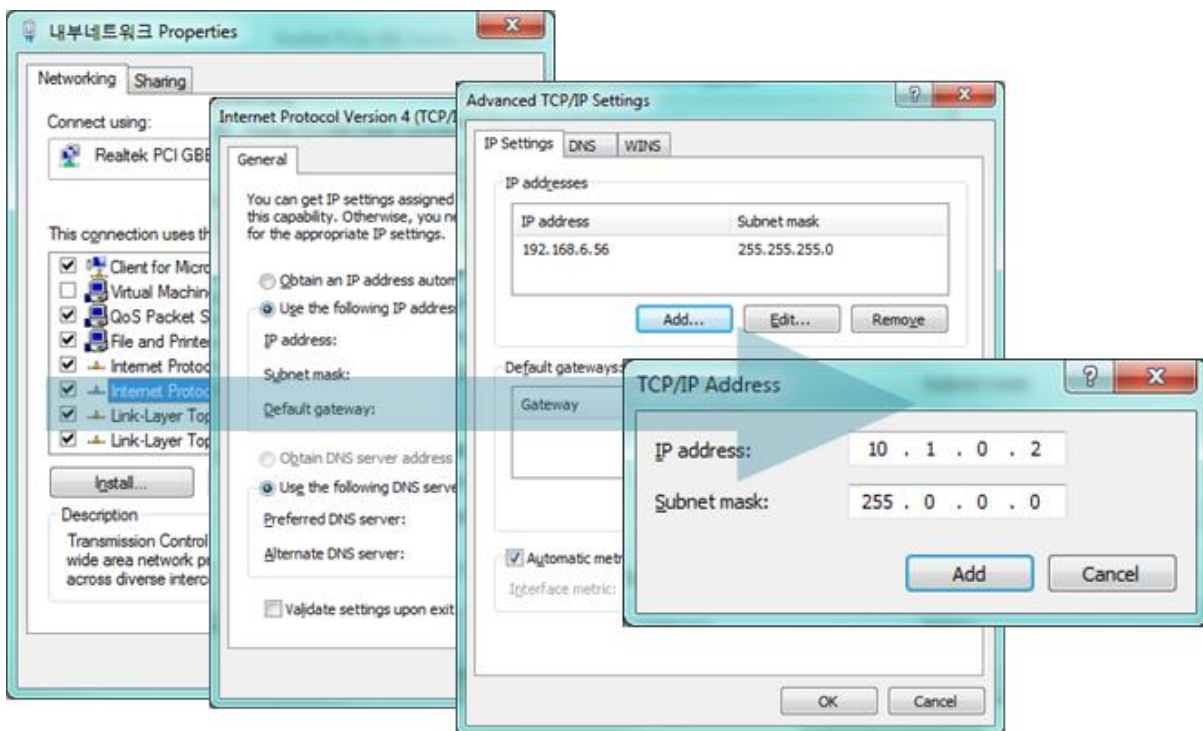

Figure 2-12 PC setting

- CSW-B85 settings

ezManager comes with CSW-B85 as a configuration tool. This software is easy to use and does not need installation since it operates on MS Windows.

First, search CSW-B85 via serial port. For test run, set all the values of parameters to the factory default except WLAN parameters.

Name		Default values
Network	Local IP Address	10.1.0.1
	Subnet Mask	255.0.0.0
	IPv6	Disabled
Serial Port (COM1)	Serial Type	RS232
	Baud Rate	19,200bps
	Parity	NONE
	Data Bits	8
	Stop Bit	1
	Flow Control	NONE
	Communication mode	TCP Server
WLAN	Local Port	1470
	Topology	Infrastructure
	SSID	sollae
	Antenna	Internal Antenna
Option	Security Settings	Disabled
	TELNET	Enabled
	IP Address Search	Enabled

Table 2-1 default values of major parameters

☞ ***To use an external antenna, connect the antenna to U.FL socket and set the parameter to External Antenna.***

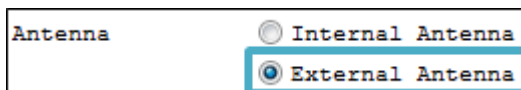

Figure 2-13 parameter for selecting antenna

## 2.3 Simple Test

If you press the [Simple Test] button, the test program will be shown on your screen.

- Connecting to the CSW-B85 via LAN

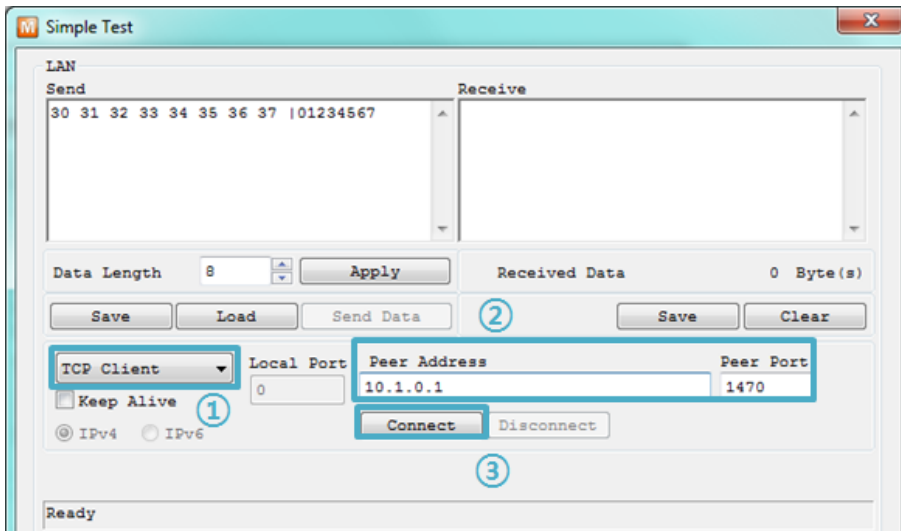

Figure 2-14 settings for TCP connection

- ① Select [TCP Client]
- ② Input correct IP address and port number of CSW-B85
- ③ Click the [Connect] button. (In the case of TCP Server, it will be [Listen] button)

- Opening RS232 Port

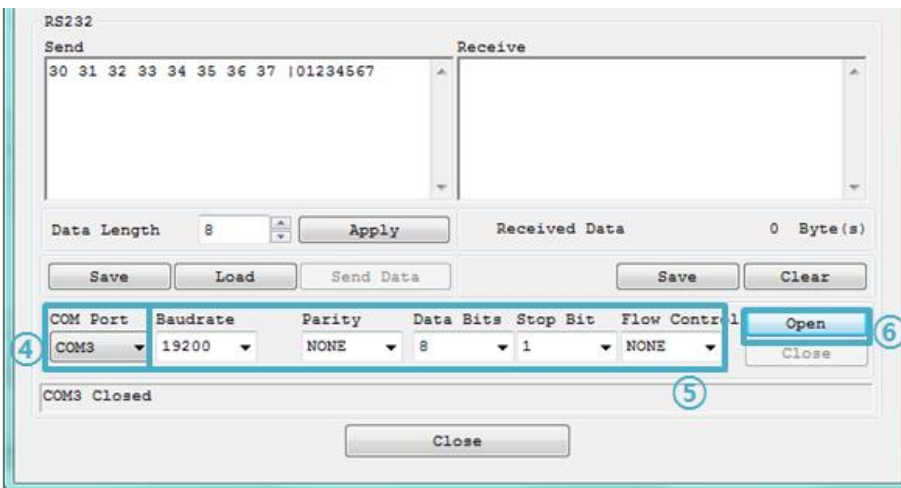

Figure 2-15 opening COM Port

- ④ Select COM port which the CSW-B85 is connected to
- ⑤ Make sure that all the parameters are the same with CSW-B85
- ⑥ Press the [Open] button

- Confirm the TCP Connection and COM port status

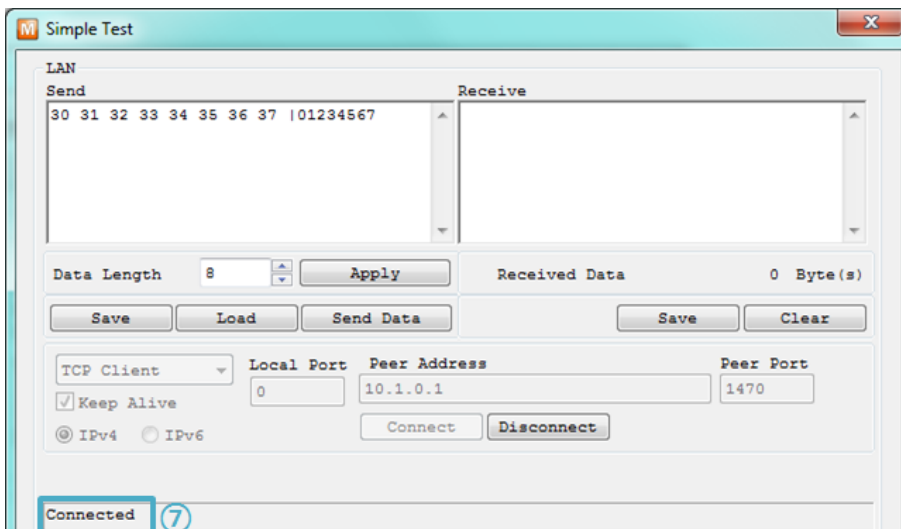

Figure 2-16 TCP Connected message

- ⑦ Check the message if the TCP connection has been established well

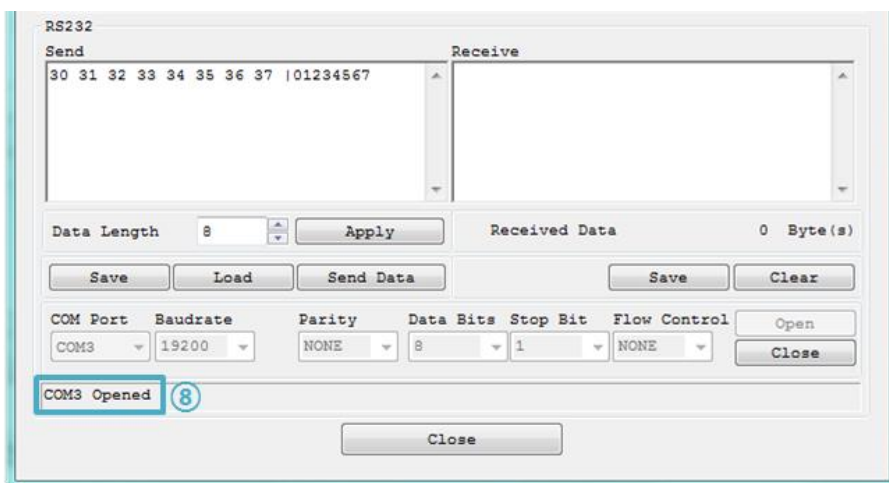

Figure 2-17 COM Port open message

- ⑧ Check the message if the COM port has been opened

● Data transmission test

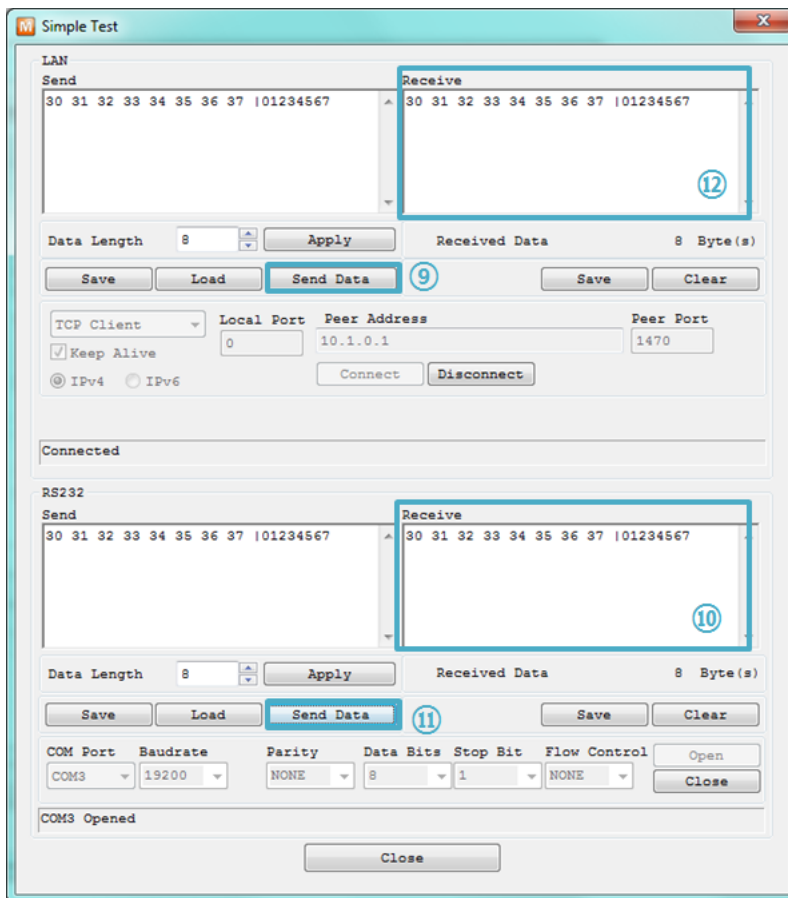

Figure 2-18 successful data transmission

- ⑨ Click [Send data] on the LAN part
- ⑩ Check the data from ⑨ has been shown

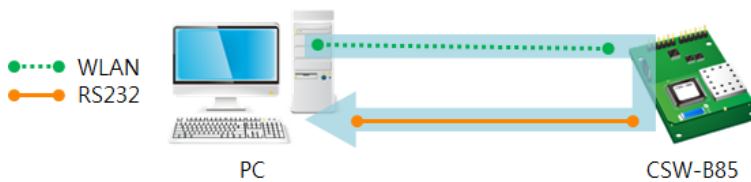

Figure 2-19 WLAN → RS232

- ⑪ Press [Send data] on the RS232 part
- ⑫ Check the data from ⑪ has been received

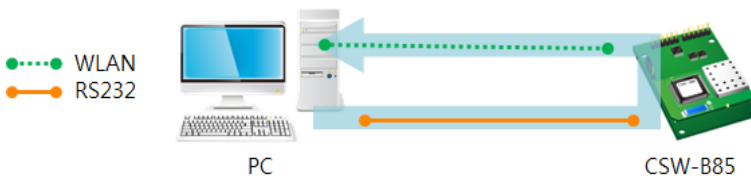

Figure 2-20 RS232 → WLAN



## 3 Configuration

### 3.1 Configuration with ezManager

#### 3.1.1 Configuration via Serial

- Requirements

Make sure the connection between your PC and CSW-B85 using RS232 cross cable. CSW-B85 has to be operated in the Serial Configuration mode.

- Procedures

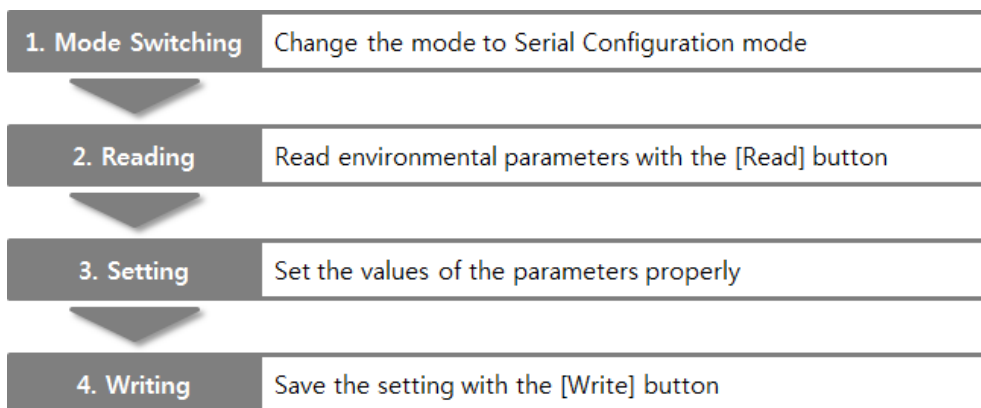

Figure 3-1 configuration procedures via Serial

### 3.1.2 Configuration via WLAN

If CSW-B85 is connected with your PC on wireless LAN, you can search and configure CSW-B85 with [MAC Address] and [IP Address] tab on ezManager.

- Requirements

CSW-B85 has to be connected to PC on the same network. Connect it to wireless network, using Ad-hoc, Infrastructure or Soft AP mode.

- Procedures

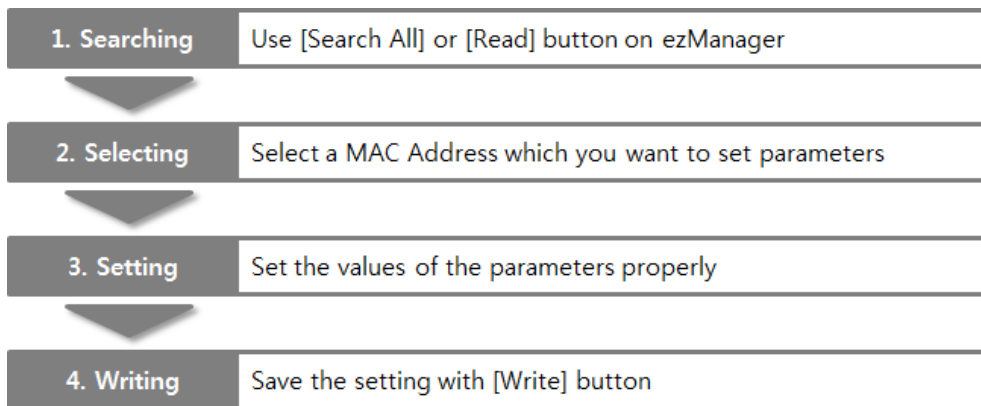

Figure 3-2 procedures for configuration via WLAN

### 3.2 AT command

In the AT command mode, you can change some parameters through the serial port.

- Requirements

Make sure the connection between your PC and CSW-B85 using RS232 cross cable (In the case of using EVB). To use this mode, CSW-B85 has to be set to [AT command] mode on ezManager.

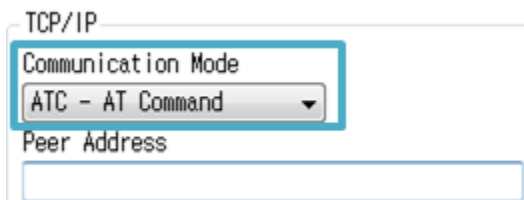

Figure 3-3 setting the communication mode to the AT command

- Procedures

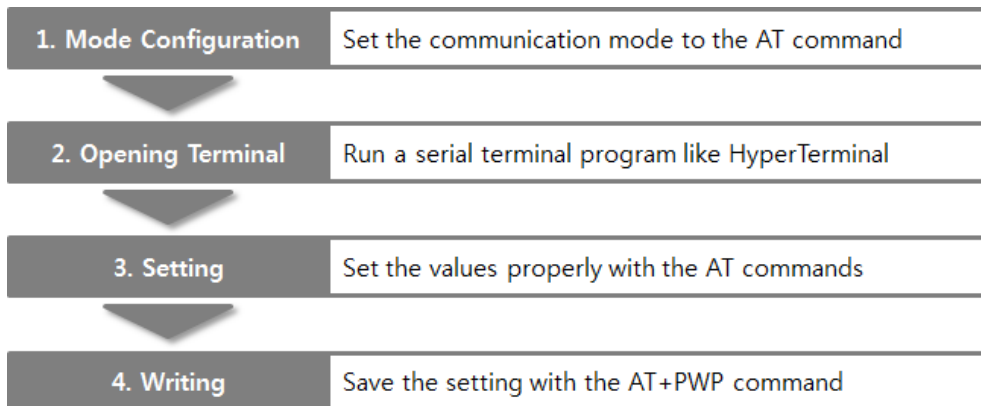

Figure 3-4 configuration procedures with AT command

- Available settings

Items	Available parameters
IP Address	Local IP Address, DHCP, Subnet Mask, Gateway IP Address and etc.
TCP connection	Local Port, Peer Address (IP Address or Host name), and etc.
WLAN	Topology, SSID, WEP, WPA-PSK, WPA2-PSK and etc.
Option	ESC code sending option, timeout and etc.

Table 3-1 available settings by AT command

### 3.3 WEB Configuration

Use a WEB browser for configuration.

- Requirements

Product should be operated in Serial Configuration mode, activating background Soft AP function. A WEB browser and Wireless LAN adaptor are required on your PC.

- Procedures

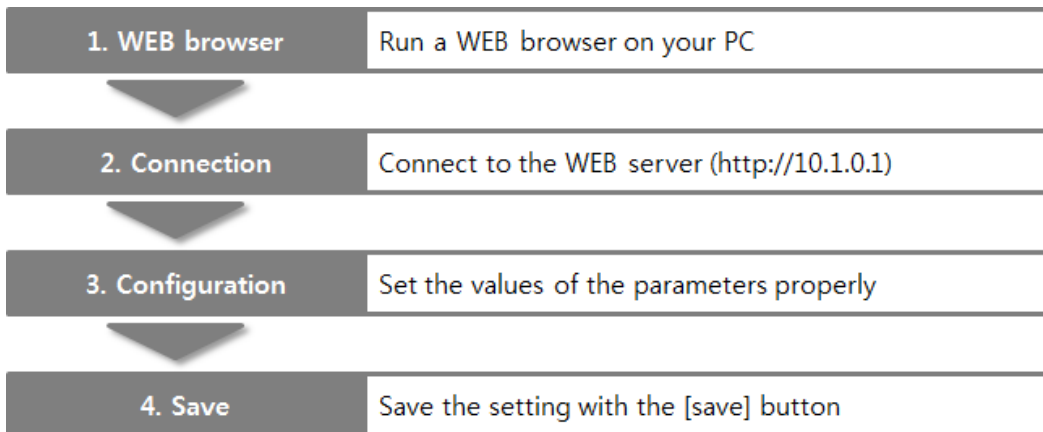

Figure 3-5 WEB configuration

- WEB Configuration Page

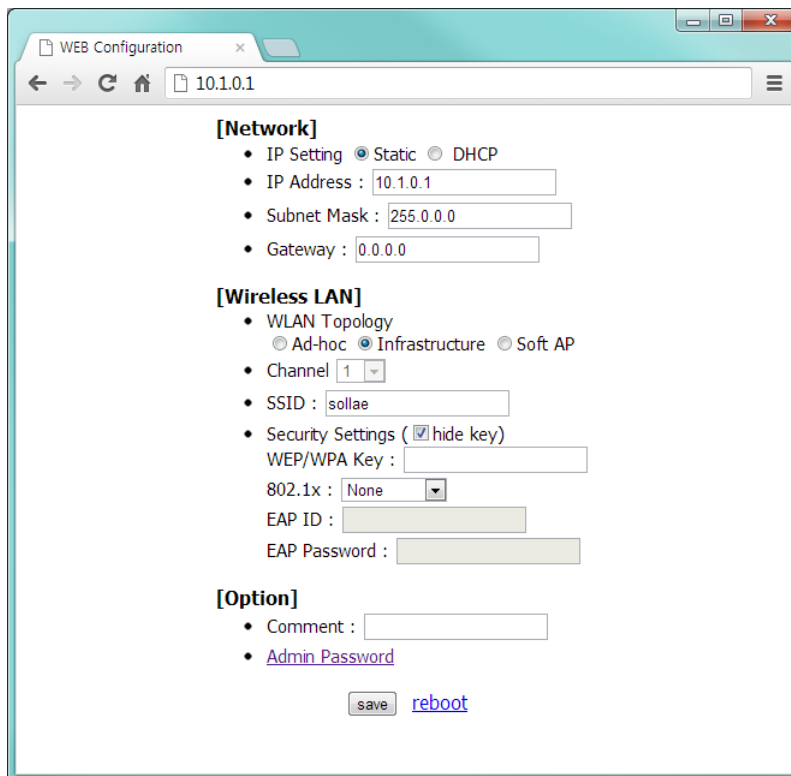

Figure 3-6 WEB configuration page

- Available settings

Items	Available parameters
Network	IP Setting (Static / DHCP), IP Address, Subnet Mask and Gateway
TCP connection	WLAN Topology, Channel, SSID and Security Settings
Option	Comment and Admin Password
etc.	Reboot

Table 3-2 available settings by WEB configuration

## 4 Operation Modes

### 4.1 What is the Operation Mode?

Each of three operation modes is defined for specific purpose as follows:

- Normal mode
 

This mode is for normal data communication and there are 4 different connection modes. Configuring parameters is also available in this mode.
- Serial Configuration mode
 

This mode is for configuring environmental parameters through the serial port. Background Soft AP function is automatically activated in this mode.
- ISP mode
 

This mode is only for changing firmware.

### 4.2 Changing modes

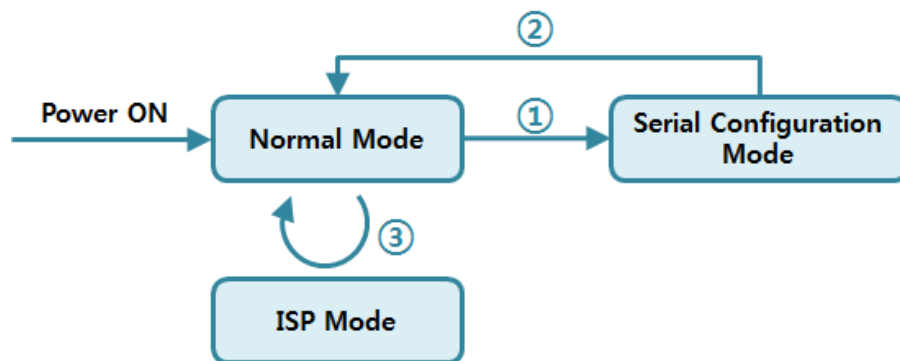

Figure 4-1 diagram for changing modes

- ① Connect pin #1-2 of J2(N-C), or connect pin #2-3 of J1(ISP) less than 1 second.

☞ ***Please refer to the table 1-8 or 1-9 to switch the operation mode from normal mode to serial configuration mode.***

- ② Reset or input "g 0" command.  
 ③ Transfer a firmware by ezManager

### 4.3 Comparison with each mode

The table below shows comparison of each mode in serial port operation.

Name	Serial port	Type
Normal	configured value	LVTTL / RS232 / RS422 / RS485
Serial Configuration	115,200/N/8/1	LVTTL / RS232
ISP	115,200/N/8/1	LVTTL / RS232

Table 4-1 comparison of each mode

### 4.4 Normal Mode

#### 4.4.1 WLAN mode

CSW-B85 supports three types of WLAN mode.

WLAN mode	Description
Ad-hoc	WLAN is composed to only stations without an AP
Infrastructure	WLAN is composed to an AP and clients
Soft AP	AP acts both an AP and a client.

Table 4-2 comparison of WLAN mode 1

Required and available values for each WLAN mode are as follows:

WLAN mode	Channel	SSID	WEP	WPA
Ad-hoc	required	required	optional	not available
Infrastructure	not available	required	optional	optional
Soft AP	required	required	optional	not available

Table 4-3 comparison of WLAN mode 2

☞ **Soft AP is automatically activated on the background when CSW-B85 is in Serial Configuration mode with SSID of "cfg\_[MAC Address]" format.**

#### 4.4.2 Communication mode

In normal mode, there are four connection types to communicate with a remote host.

Mode	Description
TCP Server	Wait connection request from TCP clients (Passive Connection)
TCP Client	Send connection request to a TCP server (Active Connection)
AT Command	Control connections by AC commands (Active / Passive Connection)
UDP	Communicate by block units without connection

Table 4-4 comparison of communication mode 1

Mode	Protocol	Connection	Requirements about Modifying S/W of serial devices	Serial configuration	Topology
TCP Server	TCP	Passive	N/A	N/A	1:1
TCP Client		Active	N/A	N/A	1:1
AT Command		Both	Required	Available	1:1
UDP	UDP	-	N/A	N/A	N:M

Table 4-5 comparison of communication mode 2

☞ ***N/A: Not Applicable or Not Available.***



## 4.5 Serial Configuration Mode

### 4.5.1 Configuring Parameters

This is a mode for setting environmental parameters through the serial port. If you cannot use the WLAN, this mode is only way to configure the parameters. Click the [Read] button on the [Serial] tab of ezManager after entering this mode.

☞ *Refer to the [Serial Management Protocol] document on our website for details.*

### 4.5.2 Revoking Security Options

CSW-B85 offers restriction for security like filtering with password or MAC and IP address. In the serial configuration mode, you can revoke all of these options. When you forget the password, enter this mode to change or delete it.

### 4.5.3 Background Soft AP function

CSW-B85 activates Soft AP function in background while operating under Serial Configuration mode.

## 4.6 ISP Mode

### 4.6.1 Upgrading Firmware

ISP mode is for upgrading firmware. Upgrading Firmware is implemented by ezManager. For more details about this, please refer to the chapter 6.1.

## 5 Communication Modes

### 5.1 TCP Server

In this mode, CSW-B85 listens to a TCP connection request from remote hosts. Then, it accepts a connection. After the connection is established, CSW-B85 converts the raw data from the serial port to TCP/IP data and sends it to the network and vice versa.

#### 5.1.1 Key parameters

- Local Port

This is server's port number on which a server listens for a TCP connection.

- Event Byte

With setting event bytes, you can handle the serial data of the serial buffer before a TCP connection is established.

Value	Description
0	CSW-B85 does not send the data
Otherwise (512 or under)	CSW-B85 sends the data right after a connection is established. 512 or under bytes are strongly recommended.

Table 5-1 Event Byte

- Timeout

If there is no transmission data for specific time the connection will be terminated.

- Notify IP Change

This function is to notify about changed IP addresses to a management server. Not only can the TCP/UDP protocol be used, but Dynamic Domain Name Service (DDNS).

- Access restriction

You can block TCP connections from unauthorized hosts by using this option. Both IP and MAC address are available.

### 5.1.2 Examples

- A situation that [Event Byte] is set to 0.

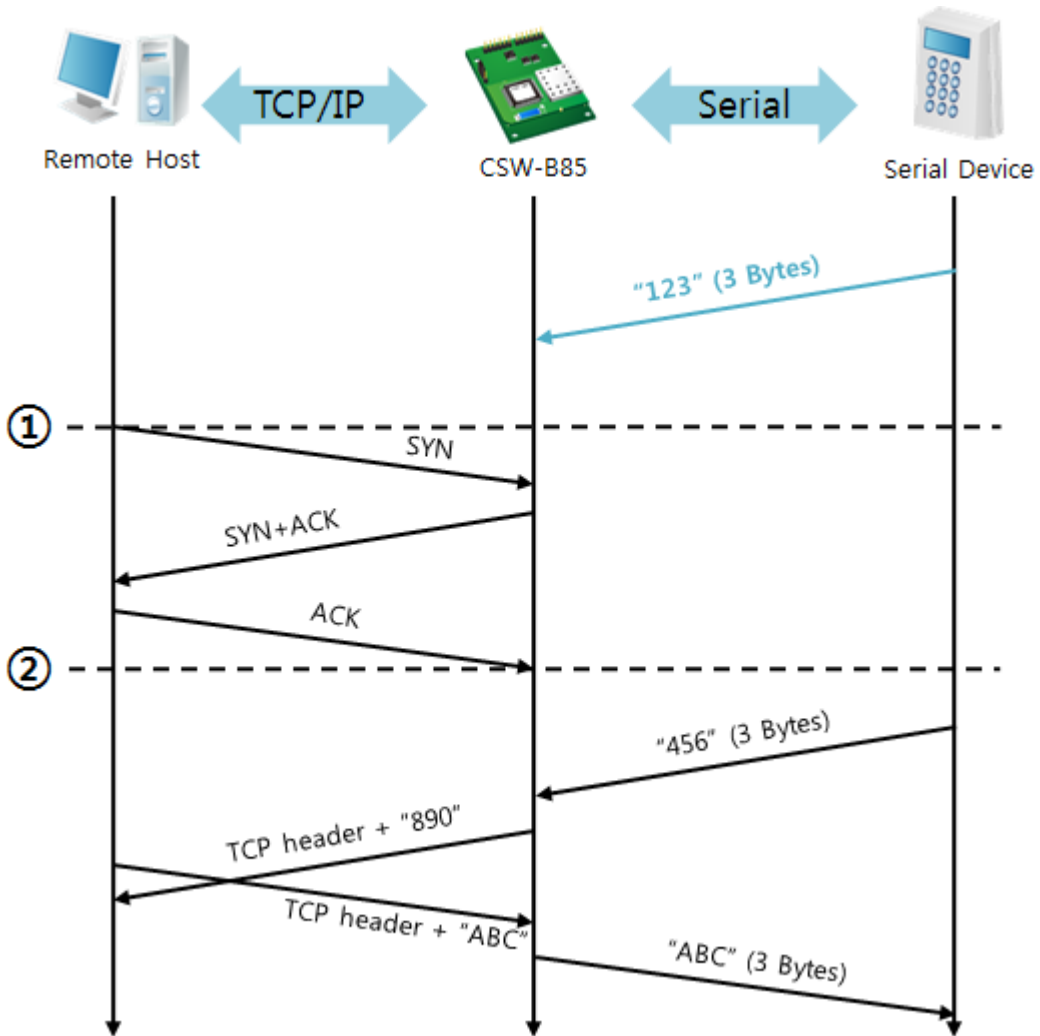

Figure 5-1 time chart

Time	States
~	Before Three-way handshaking
①	Remote host sends a connection request (SYN) segment.
~	Processes of the connection
②	The connection is established.
~	Data communication is implemented on both sides.

Table 5-2 states of each point

Look at the blue arrow above. The data "123" from the serial port is sent before Three-way handshaking. In this case, the data cannot be sent because the [Event Byte] is set to 0 (zero).

- A situation that [Event Byte] is set to 1

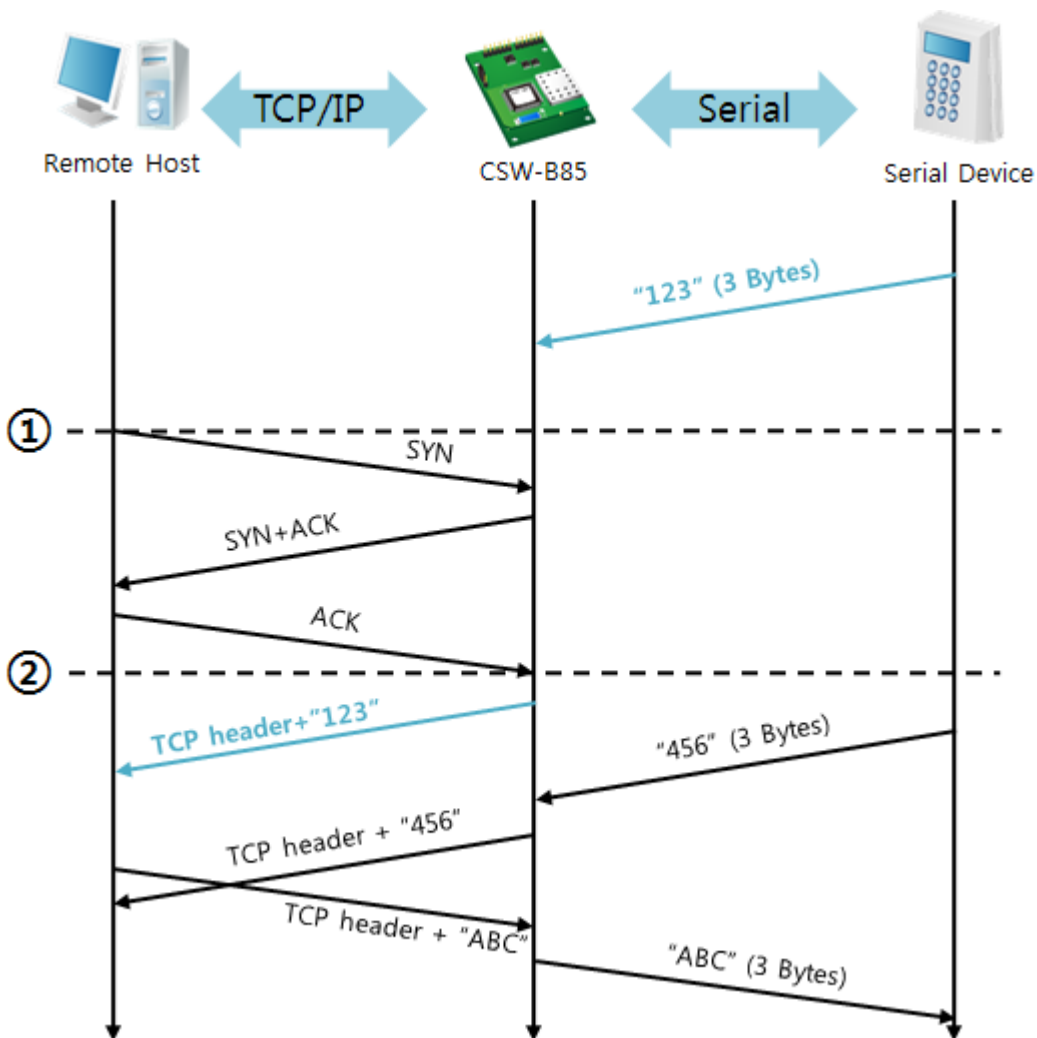

Figure 5-2 time chart

Time	States
~	Before Three-way handshaking
①	Remote host sends connection request (SYN) segment.
~	Processes of the connection
②	The connection is established.
~	Data communication is implemented on both sides.

Table 5-3 states of each point

Look at the blue arrow above. The data "123" is sent right after Three-way handshaking because the value of [Event Byte] is set to 1.

- A situation that [Timeout] is set to 5

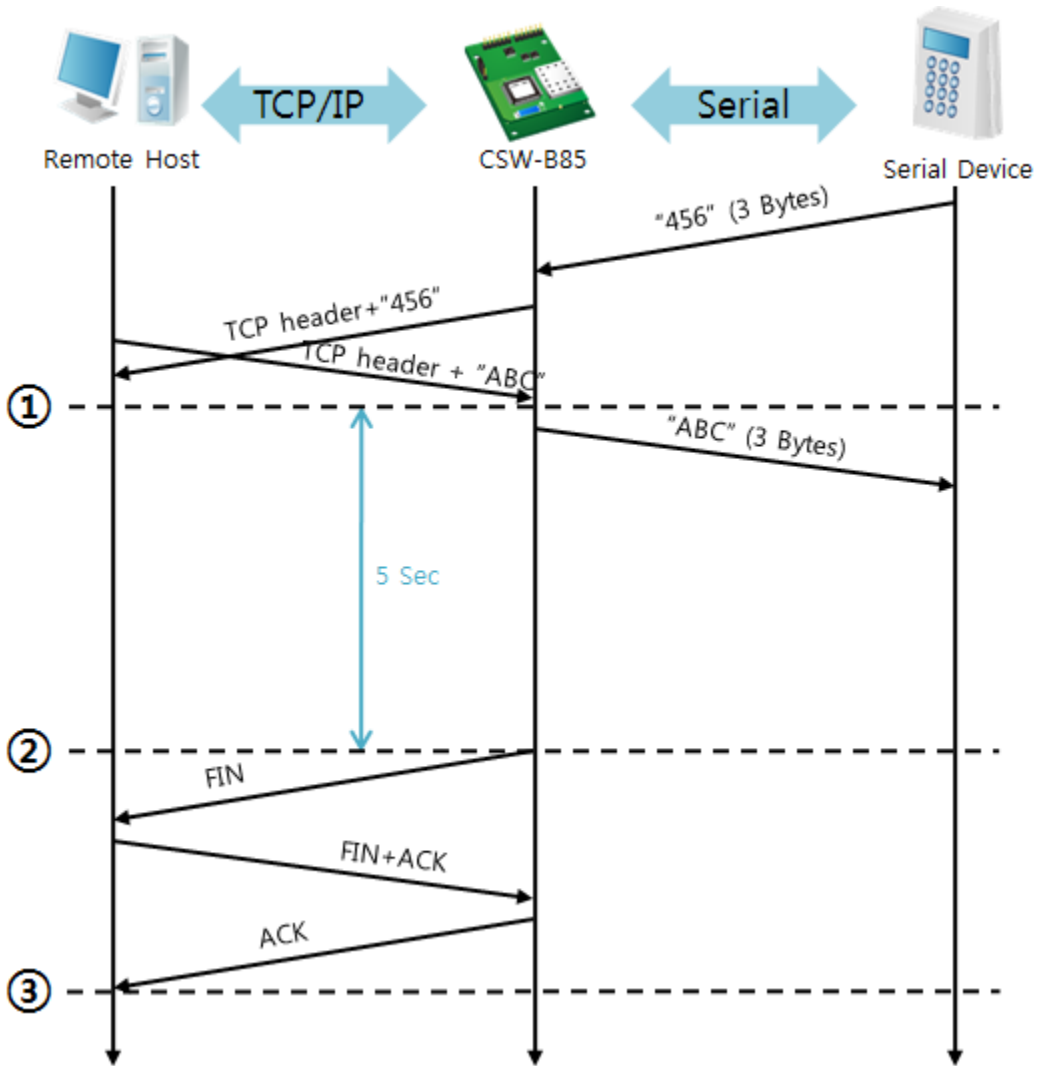

Figure 5-3 time chart

Time	States
~	Data communication on both sides
①	The last segment arrives at the CSW-B85.
~	No data communication for 5 seconds
②	CSW-B85 sends disconnection request (FIN) to a remote host.
~	Processes of the disconnection
③	The connection is terminated.
~	CSW-B85 listens to connection requests.

Table 5-4 states of each point

## 5.2 TCP Client

In this mode, CSW-B85 sends request segments to a TCP server with information of [Peer Address] and [Peer Port]. Once a host is listening, the connection will be established. After then, CSW-B85 converts the raw data from the serial port to TCP/IP data, and sends them to the network and vice versa.

### 5.2.1 Key parameters

- Peer Address

This item is an address of TCP server.

- Peer Port

[Peer Port] is the port number of TCP server.

- Event Byte

CSW-B85 can decide when to send the connection request parameter.

Value	The point of time to send request segment
0	Right after CSW-B85 boots up
Otherwise (512 or under)	Right after the bytes set to [Event Byte] have been received from the serial port Setting to less than 512 bytes is strongly recommended.

Table 5-5 the operation of Event Byte 1

In addition, you can handle the serial data before a TCP connection is established with this parameter.

Value	Description
0	CSW-B85 does not send the data.
Otherwise (512 or under)	CSW-B85 sends the data right after a connection is established. Setting to less than 512 bytes is strongly recommended.

Table 5-6 the operation of Event Byte 2

- Timeout

If there is no data transmission for specific time, the connection would be terminated.

- TCP Server

This check option enables you to get to the TCP Server / Client mode. In this mode, CSW-B85 can be operated as a TCP server or client without changing its settings.

- DNS IP Address

[DNS IP Address] is needed when you use a host name instead of an IP address.

### 5.2.2 Examples

- A situation that [Event Byte] is set to 0

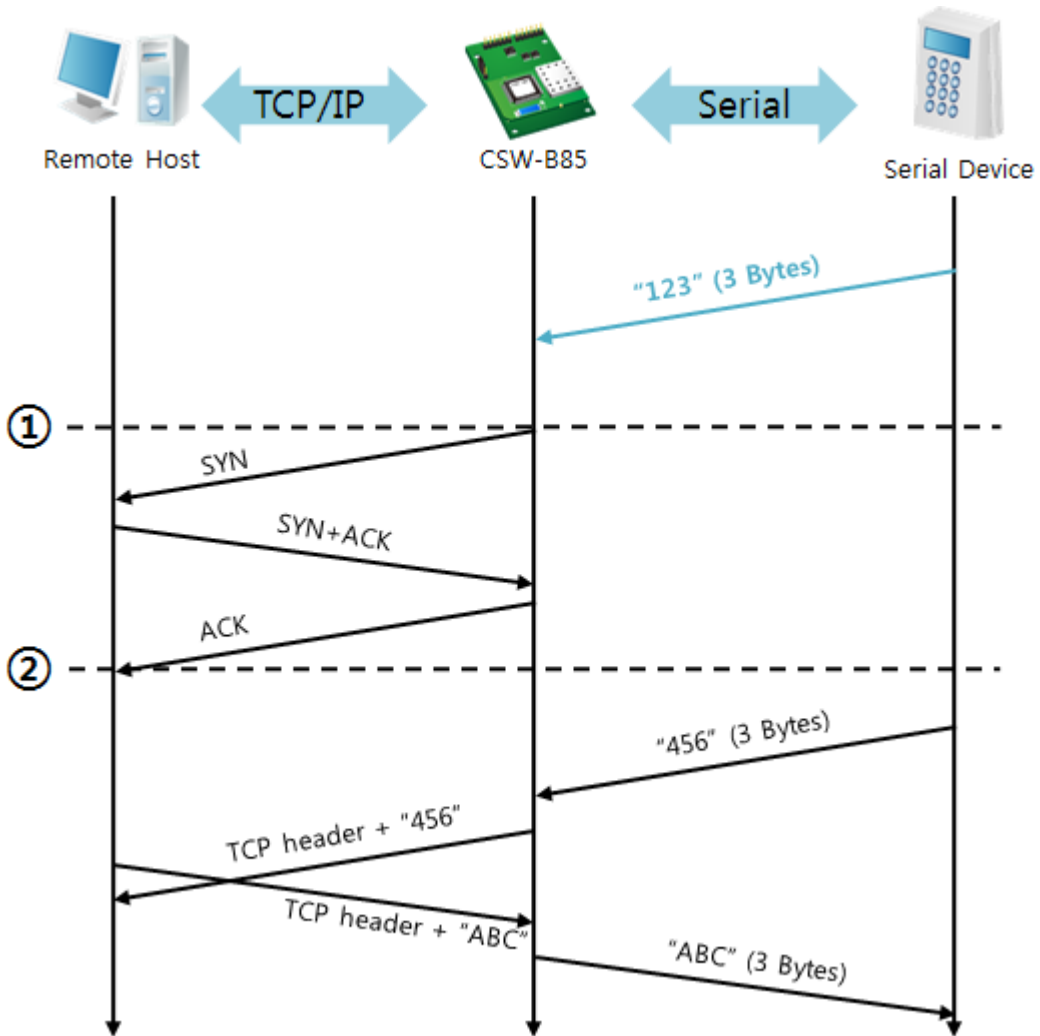

Figure 5-4 time chart

Time	States
~	Before Three-way handshaking
①	CSW-B85 sends a connection request segment.
~	processes of TCP connection
②	The connection is established.
~	data communication on both sides

Table 5-7 states of each point

Look at the blue arrow above. The data "123" from the serial port has been sent before Three-way handshaking. In this case, the data will not be sent because the [Event Byte] is set to 0 (zero).

- A situation that [Event Byte] is set to 1

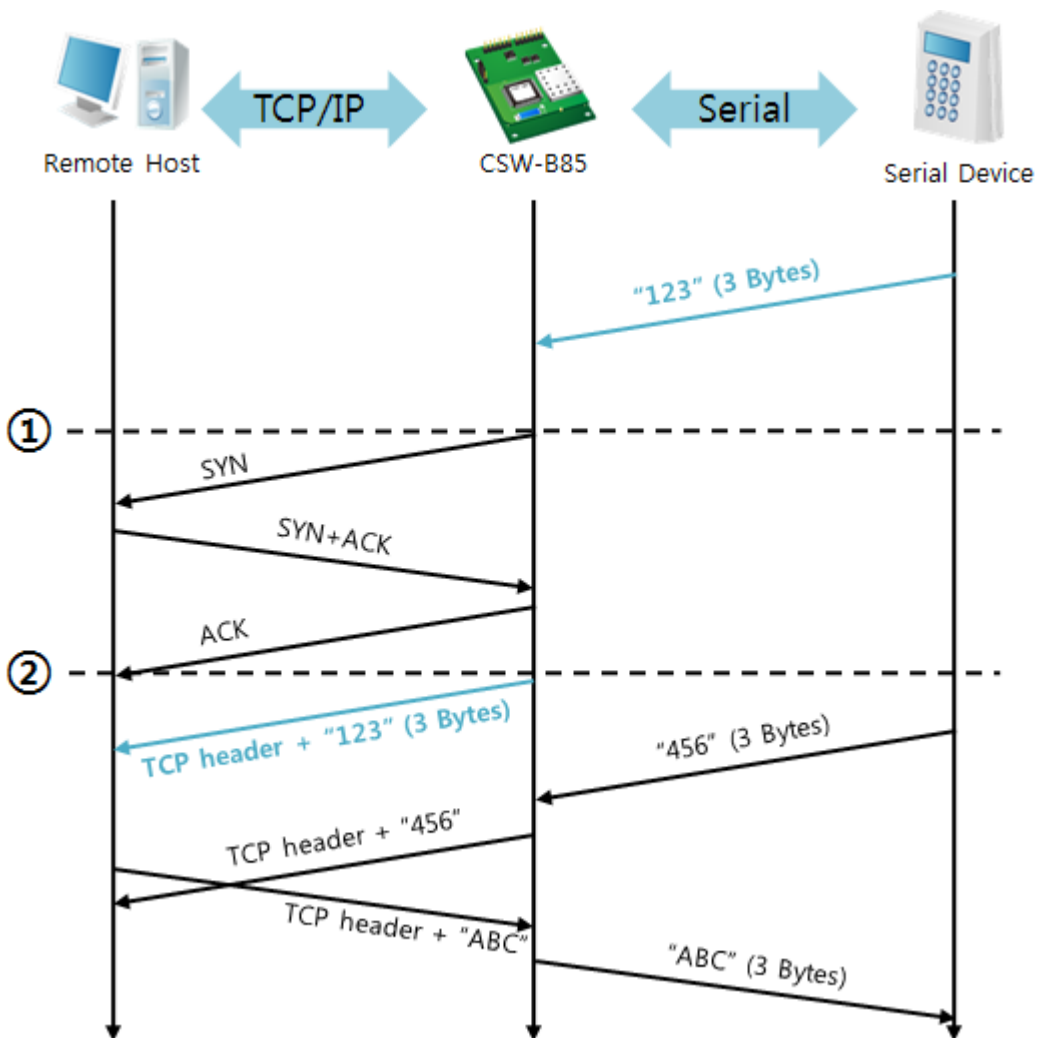

Figure 5-5 time chart

Time	States
~	CSW-B85 waits until 1 byte arrive at serial port
①	CSW-B85 sends a connection request right after receiving 3 bytes.
~	processes of the TCP connection
②	The connection is established.
~	The data "1234567" is transmitted to the remote host.

Table 5-8 states of each point

As you can see, CSW-B85 sends a request segment right after the size of the serial data becomes 1 bytes. Even though they arrive before finishing Three-way handshaking, the data "123" will be transmitted to the remote host because the [Event Byte] is set to non-zero.



- Activation of [TCP Server] option

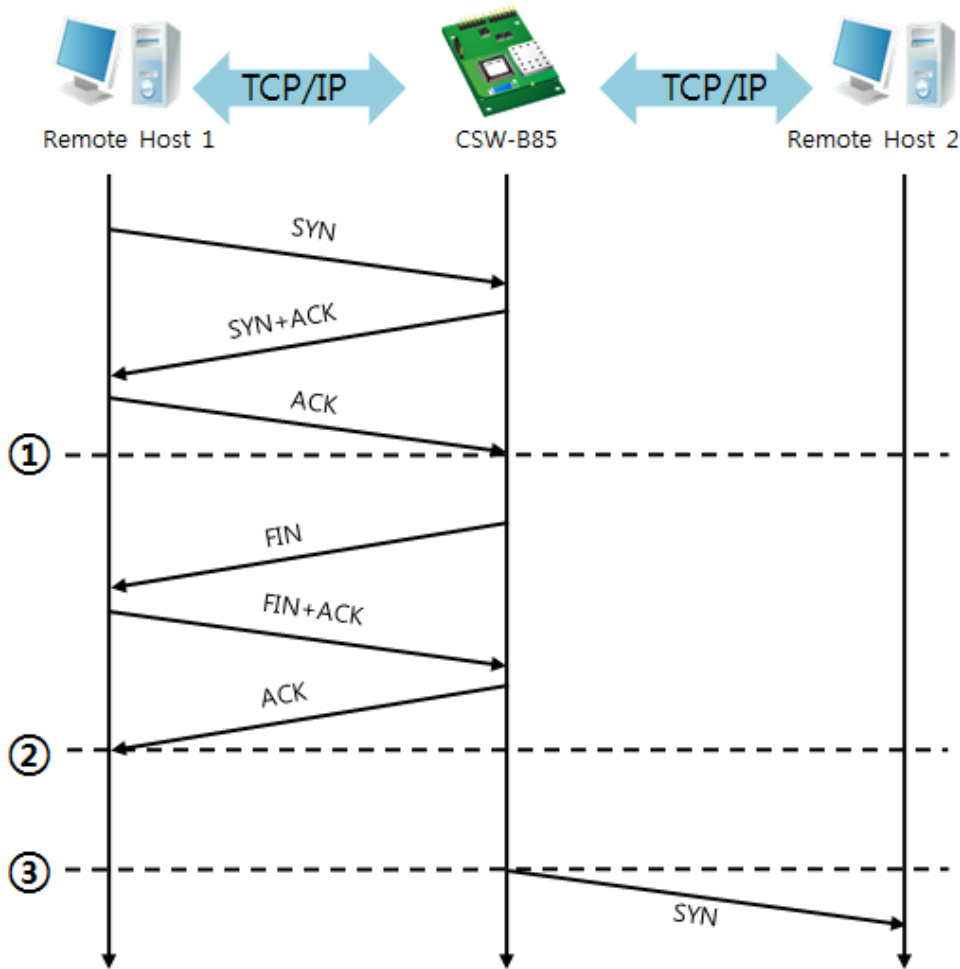

Figure 5-6 time chart

Time	States
~	CSW-B85 listens to connection requests
①	The connection has been established
~	CSW-B85 is online and processes of the disconnection
②	The connection is terminated
~	Both sides are offline
③	Sends TCP connection request segment

Table 5-9 states of each point

The TCP Server / Client mode can be useful option by using [Event Byte] and [Timeout]. Note that only one TCP connection can be established at the same time, so users should consider setting [Timeout] properly.

## 5.3 AT Command

In AT command mode, you can control CSW-B85 with AT commands like a controlling modem. Active and passive TCP connections are available while UDP is not. And you are allowed to configure some environmental parameters with extended commands.

### 5.3.1 Key parameters

The configuration should be implemented via the serial port.

Commands	Description	Examples
+PLIP	Local IP Address	at+plip=10.1.0.1<CR>
+PLP	Local Port	at+plp=1470<CR>
+PRIP	Peer IP Address	at+prip=10.1.0.2<CR>
+PRP	Peer Port	at+prp=1470<CR>
+PDC	DHCP	at+pdc=1<CR>
+PTO	Timeout	at+pto=10<CR>
+WCCT	WLAN Topology	at+wcct=1<CR>
+WSSID	SSID	at+wssid="sollae"<CR>
+WANT	Antenna	at+want=0<CR>
+PWP	Store setting	at+pwp<CR>

Table 5-10 some of extended AT commands for configuration

- Related items with IP Address and Local Port
  - Local port can be set as well as IP address related parameters like IP Address, Subnet Mask and Gateway IP Address.
- Peer Address / Peer Port
  - IP address and local port of a remote host can be set.
- Type of assigning IP address: Manual, DHCP
  - Not only is manual setting available, also automatic assigning protocol (DHCP).
- WLAN parameters
  - WLAN Topology, SSID and antenna can be configured by the above commands.
- Others
  - Some of options including [Timeout] can be configured in this mode

☞ **Refer to the [AT Command mode] document on our website for details.**

### 5.3.2 Examples

- TCP Server – setting parameters and passive connection

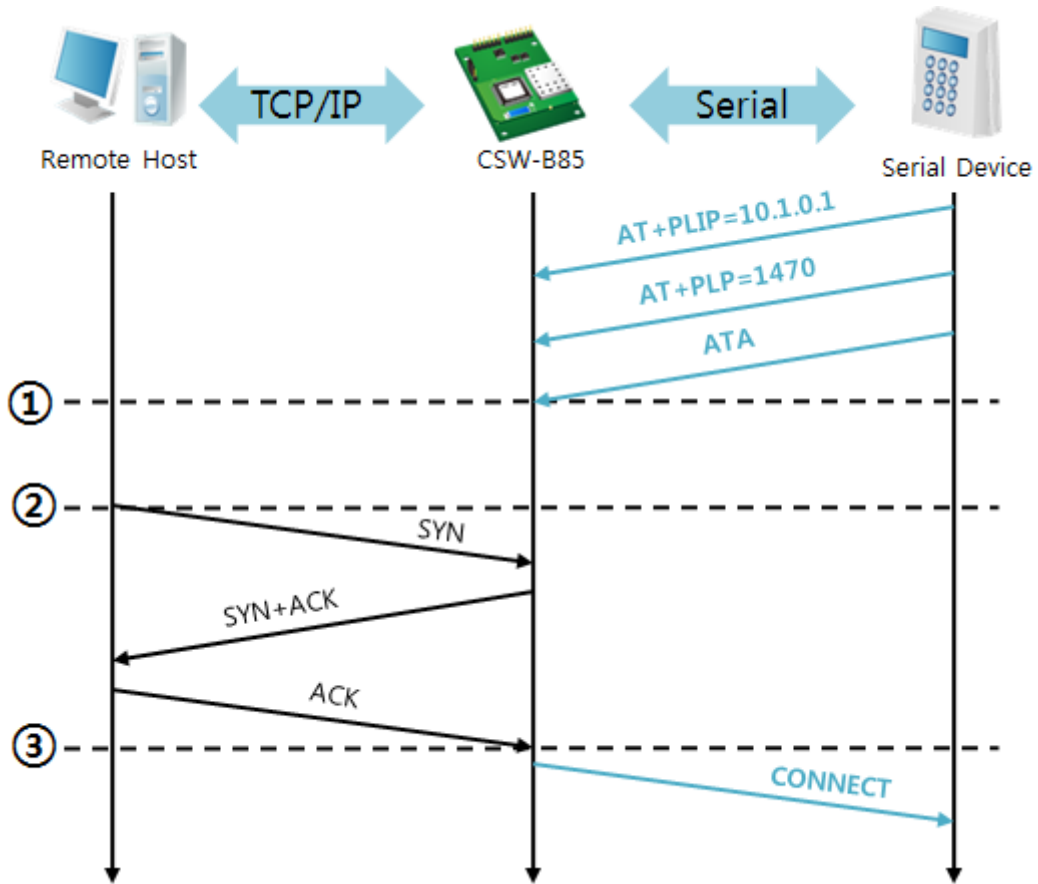

Figure 5-7 time chart

Time	States
~	configuring parameters with AT commands
①	ATA command has arrived.
~	CSW-B85 listens to TCP connection requests.
②	A remote host sends SYN segment to CSW-B85.
~	processes of TCP connection
③	TCP connection is established.
~	CSW-B85 sends "CONNECT" message to the serial port.

Table 5-11 states of each point

☞ *Some of the response messages from the serial port of CSW-B85 are omitted on above figure.*

- TCP Client - setting parameters and active connection

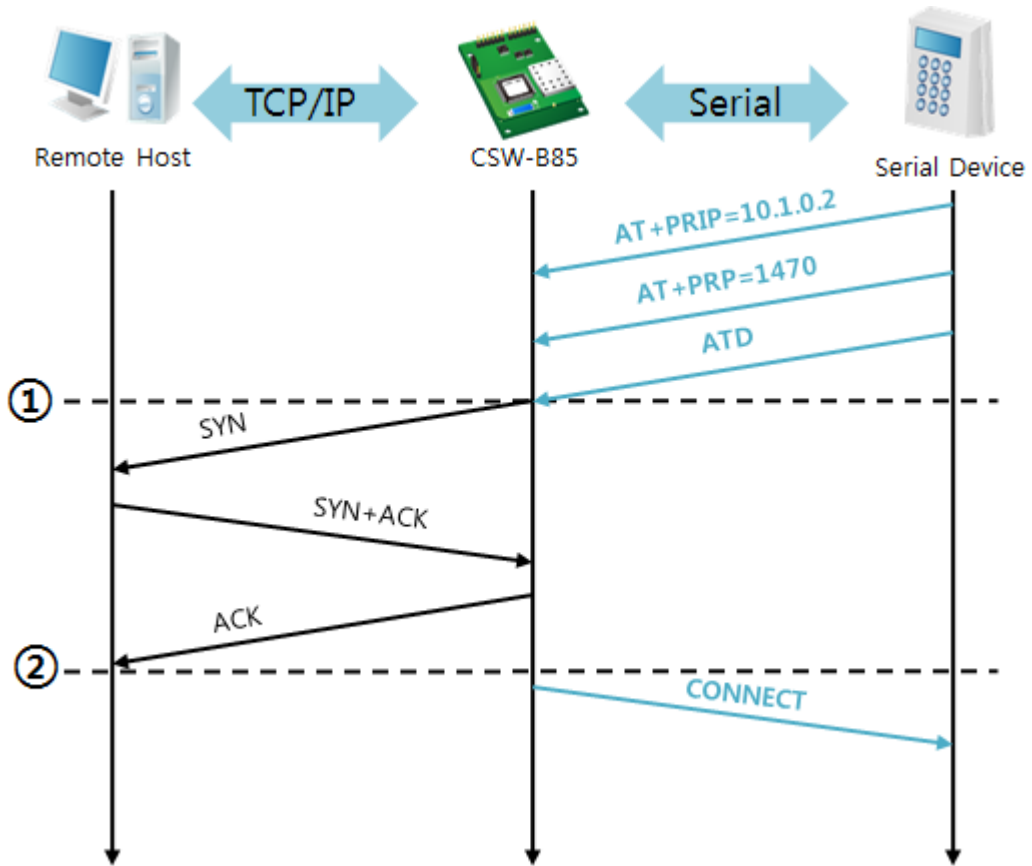

Figure 5-8 time chart

Time	States
~	configuring parameters with AT commands
①	CSW-B85 sends TCP connection request with the ATD command.
~	processes of TCP connection
②	TCP connection is established.
~	CSW-B85 sends "CONNECT" message to the serial port.

Table 5-12 states of each point

- Termination of online status – entering the AT command mode

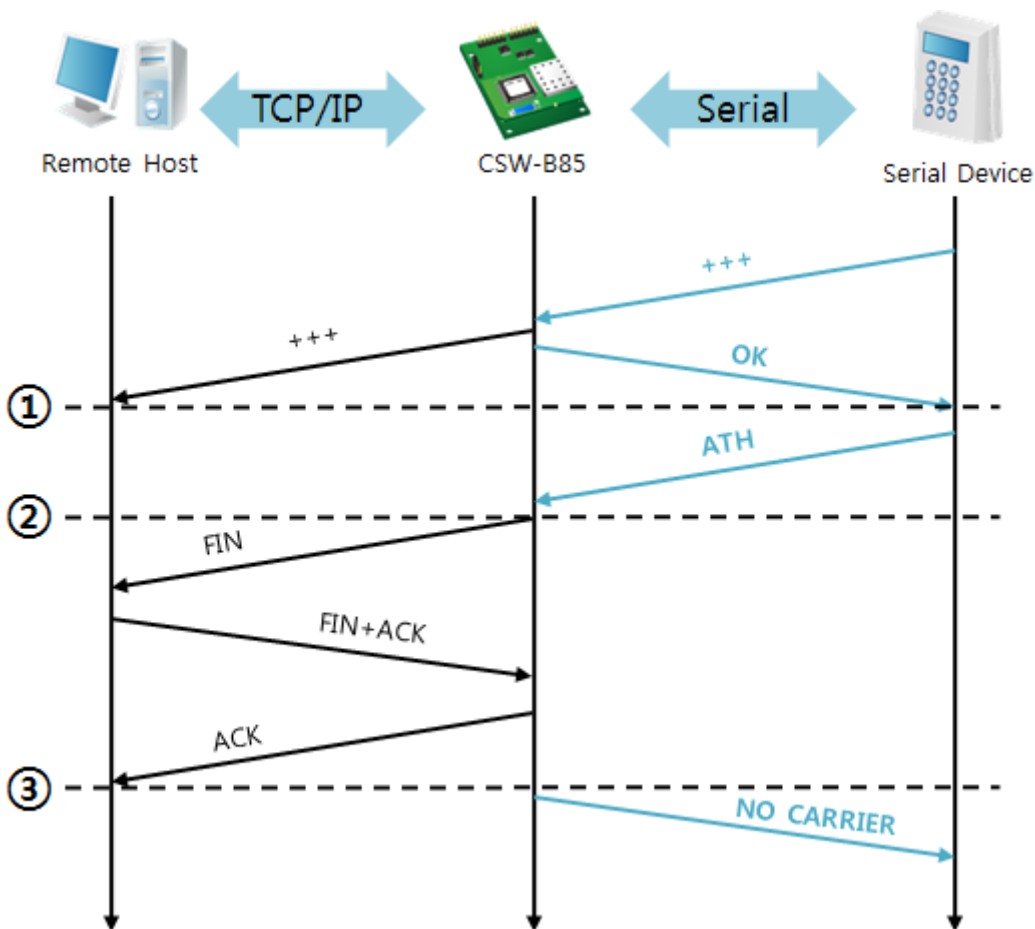

Figure 5-9 time chart

Time	States
~	TCP connection is on-line.
①	The mode is changed to "command mode" after receiving "+++".
~	command mode (TCP connection is off-line)
②	CSW-B85 sends FIN segment right after the "ATH" arrives.
~	processes of TCP disconnection
③	TCP connection is terminated
~	CSW-B85 sends "NO CARRIER" with disconnection.

Table 5-13 states of each point

CSW-B85 changes to the command state when receiving "+++". In this state, the communication with remote host is unavailable because CSW-B85 processes only AT commands. Whenever you want to go back to on-line state, just give "ATO" command.

## 5.4 UDP

UDP has no connection processes. In this mode, data is sent by block units. Therefore, data coming through CSW-B85's serial port is collected by block units to send it elsewhere.

### 5.4.1 Key parameters

- Block Size

[Block Size] is to set the time to gather data in one block. Its unit is byte. If the data in configured size of the [Block Size] comes into the serial port, CSW-B85 will send them as one block to the network. The maximum value could be 1460 bytes.

- Data Frame

[Data Frame] means the time for gathering data to make one block. Its unit is 10ms. If there is no data from the serial devices during the [Data Frame] time, CSW-B85 sends and receives data in the buffer as one block to the network.

☞ ***Once one of the two parameters, [Block Size] and [Data Frame], is sufficient, UDP packet block will be transmitted.***

- Dynamic update of Peer host

If you set the value of [Peer Address] and [Peer Port] to 0, [dynamic update of peer host] function is activated. By using this function, CSW-B85 can communicate to multiple hosts without additional setting.

### 5.4.2 Examples

- Block Size: 5 bytes / Data Frame: 1sec

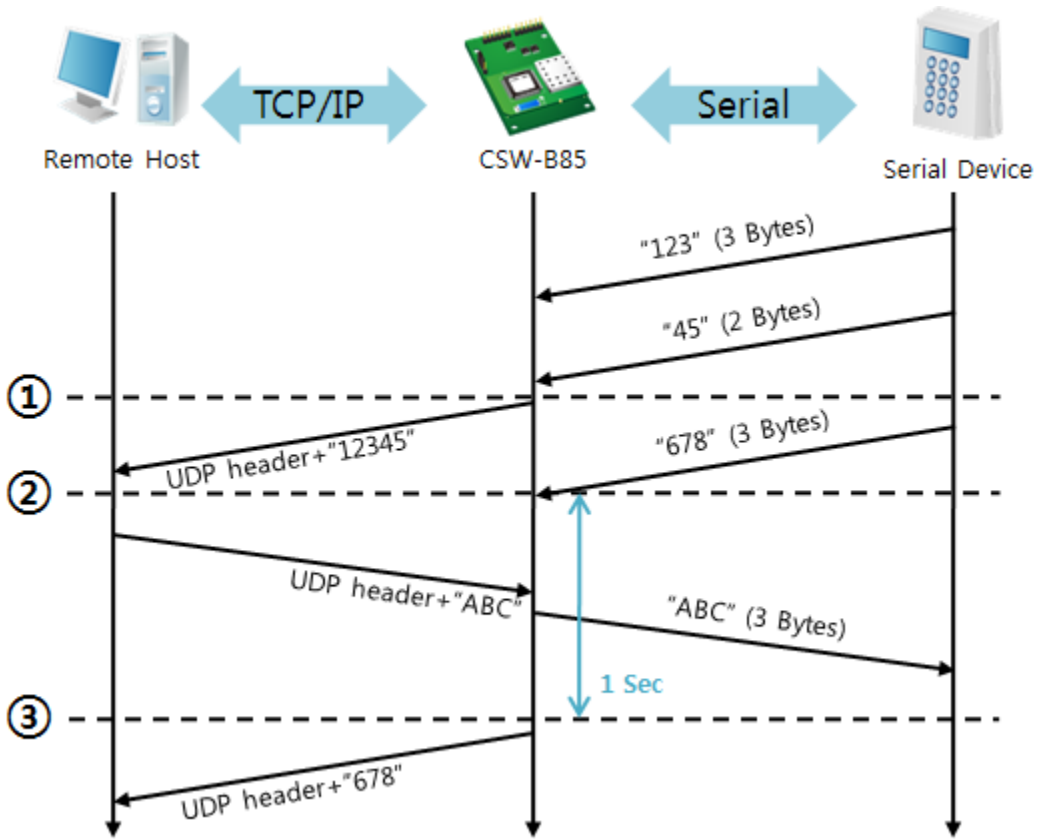

Figure 5-10 time chart

Time	States
~	CSW-B85 receives data from the serial port
①	CSW-B85 sends 5 bytes as one block based on the [Block Size].
~	Serial device sends data "678".
②	The data "678" arrives.
~	CSW-B85 sends data from the remote host to the serial device
③	1 second
~	CSW-B85 sends data "678" as one block based on the [Data Frame].

Table 5-14 states of each point

- Dynamic Update of Peer host

This is a function that CSW-B85 automatically sets its peer host with information of the last packet received from network. The source address of the packet is set to the peer host.

Parameters	Values
Peer Address	0 (None)
Peer Port	0

Table 5-15 setting for [dynamic update of peer host] function

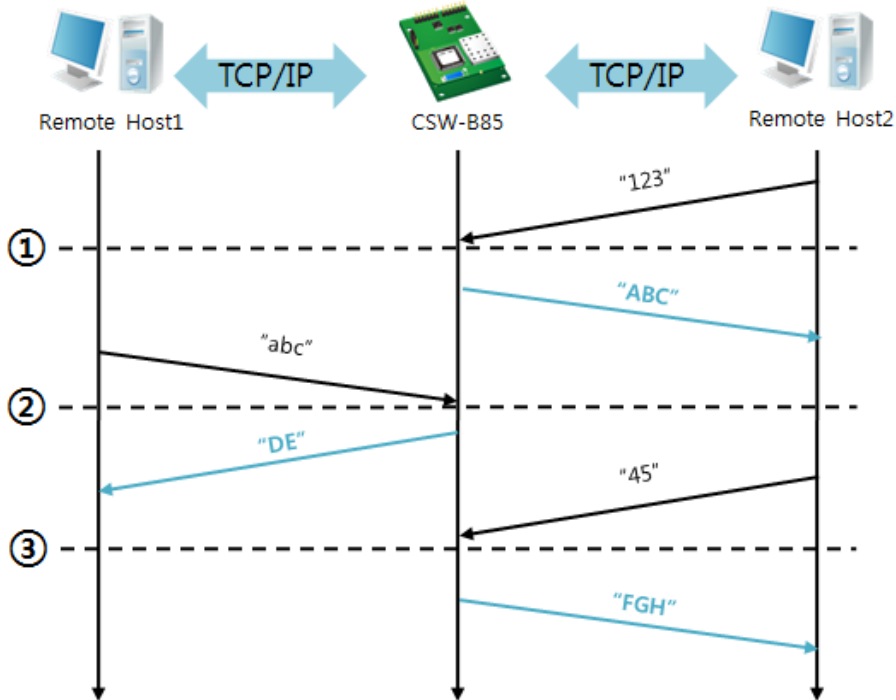

Figure 5-11 time chart

Time	States
~	Sending any UDP data to the network is impossible.
①	UDP data arrives from Remote Host 2.
~	Send UDP data to Remote Host 2.
②	UDP data arrives from Remote Host 1.
~	Send UDP data to Remote Host 1.
③	UDP data arrives from Remote Host 2.
~	Send UDP data to Remote Host 2.

Table 5-16 states of each point

☞ *The data "ABC", "DE" and "FGH" are ones that come from the serial port of CSW-B85 in the above figure.*



## 6 System Management

### 6.1 Upgrading Firmware

#### 6.1.1 Firmware

Firmware is a type of software to operate CSW-B85. If there are needs for adding functions or fixing bugs, the firmware can be modified and released. That is why we always recommend using the latest version of the firmware.

#### 6.1.2 Processes

- Downloading the latest firmware  
Download the latest firmware file uploaded at our website.
- Connecting the serial ports  
Connect the serial port of CSW-B85 to the PC's COM port with RS232 cross cable.
- Run Change F/W / HTML program for sending the F/W file  
Run the program on ezManager and click the [Change F/W / HTML] button.

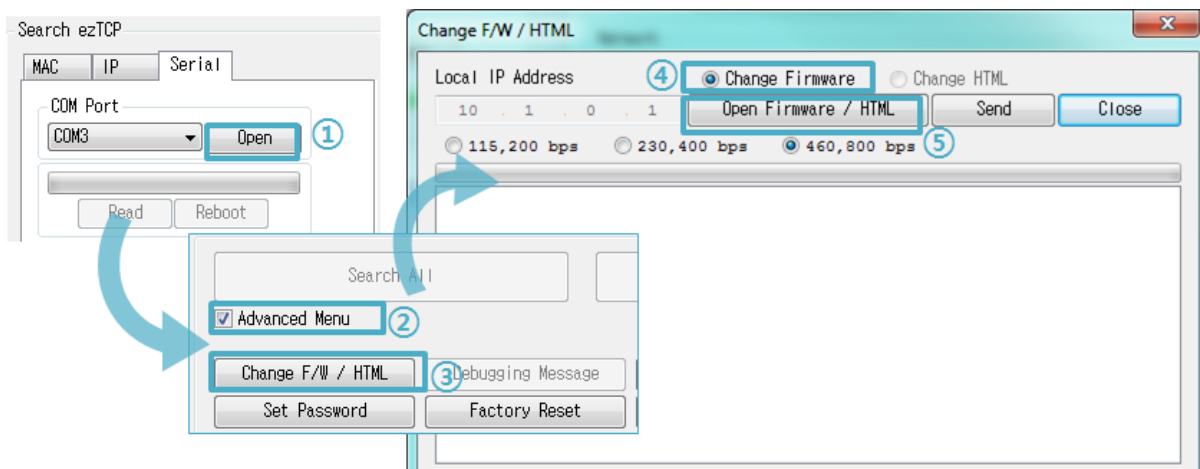

Figure 6-1 running Change F/W / HTML program for sending F/W file

- ① Press the [Open] button after selecting the COM port.
- ② Click the [Advanced Menu] check box.
- ③ Press the [Change F/W / HTML] button.
- ④ Check the [Change Firmware] radio button.
- ⑤ Press the [Open Firmware / HTML] button and choose the firmware file.

- Checking firmware file and Sending

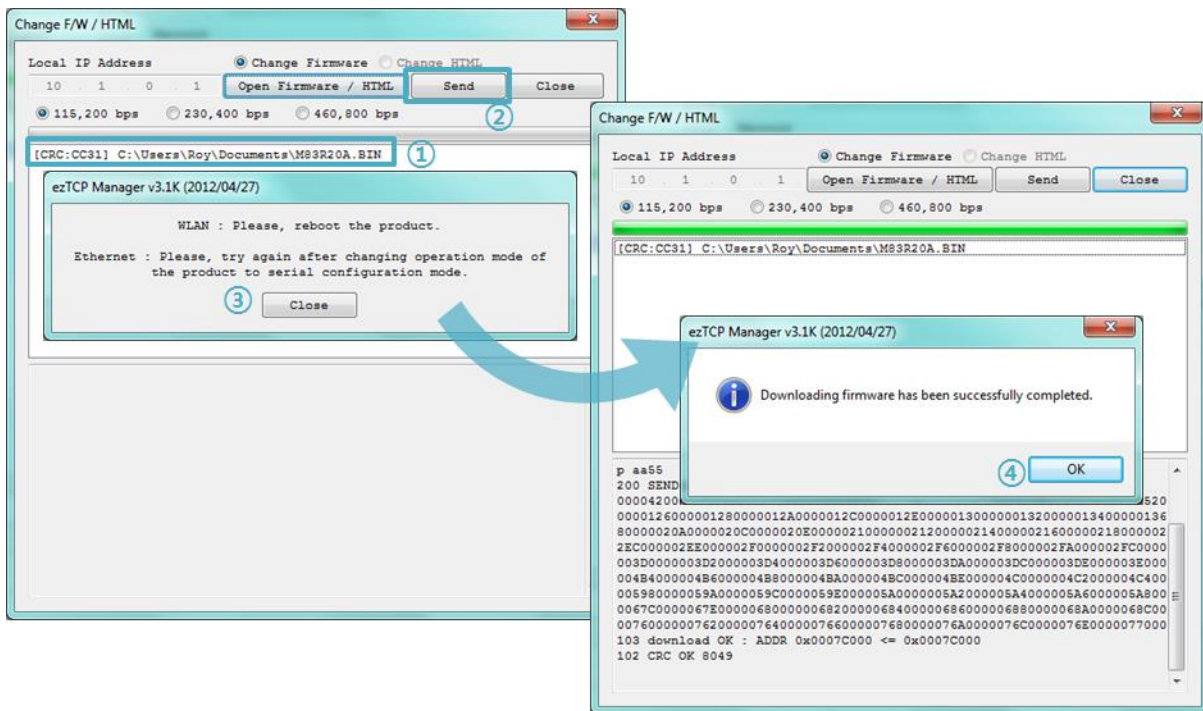

Figure 6-2 sending firmware file

- ① Check if the name and path of the firmware file are correct.
- ② Click the [Send] button.
- ③ Restart request will be shown. After rebooting, the program will send the file automatically.
- ④ Confirm the completion message.

## 6.2 Status Monitoring

### 6.2.1 TELNET

When the [TELNET] option is activated, you can remotely log in to CSW-B85. If a password is set, you should input the password.

*Starting with firmware version 2.4A, you can login by entering "sollae" without setting a password.*

After then, messages from CSW-B85 will appear like the following figure.

```
CSW-M85 Management Console v2.1C Sollae Systems
lsh>
```

Figure 6-3 log in to CSW-B85 via TELNET

Following commands help you check states of CSW-B85

Command	Option	Description	Usage
st	net	IPv4 Network Status	lsh>st net
	net6	IPv6 Network Status	lsh>st net6
	sio	Serial Port Status	lsh>st sio
	uptime	System Uptime	lsh>st uptime
sd	[OP1][OP2]	Serial data Dumping	lsh>sd 1 100
sc	[OP1][OP2]	Session Close	lsh>sc com1 close
exit	-	TELNET Session Close	lsh>exit

Table 6-1 commands for checking states

- st net

This command shows current IPv4 network states of all sessions.

```
lsh>st net
-----
proto name      local address      peer address      sendq  state
-----
TCP    tty            10.1.0.1< 23>    10.6.0.56<58989> 219  ESTABLISHED
TCP    com1           0.0.0.0< 1470>   0.0.0.0< 0>     0   LISTEN
lsh>
```

Figure 6-4 "st net" command

- st net6

This command shows current IPv6 network states of all sessions.

```
lsh>st net6
proto name local/peer address sendq state
-----
TCP6 tty 2001:db8:16:6::85< 23> 199 ESTABLISHED
2001:db8:16:6::56<59421>
TCP6 com1 2001:db8:16:6::85< 1470> 0 ESTABLISHED
2001:db8:16:6::56<59424>
lsh>
```

Figure 6-5 "st net6" command

- st sio

This command shows the number of bytes of the serial port.

```
lsh>st sio
port fmax rbmax rxbuf txbuf rx_count tx_count
-----
com1 0 0 0 0 0 0
lsh>
```

Figure 6-6 "st sio" command

- st uptime

This command shows system uptime since CSW-B85 has booted up.

```
lsh>st uptime
00:08:20.08 up 0 days
lsh>
```

Figure 6-7 "st uptime" command

- sd

"sd" command is used when users close a session. [OP1] means the number of COM port, and [OP2] means period of capturing and printing messages with 10ms unit.

```
lsh>sd 1 100
com1 dump start
com1 dump buffering time : 1000ms
lsh>tx1 => 30 31 32 33 34 35 36 37 ! 01234567
rx1 <= 30 31 32 33 34 35 36 37 ! 01234567
```

Figure 6-8 "sd" command

- sc

This command disconnects one of the current sessions. Input session name to [OP1] and "close" command to [OP2].

```
lsh>sc com1 close
com1: closed
lsh>
```

Figure 6-9 "sc" command

- exit

This command disconnects current TELNET session.



Figure 6-10 "exit" command

### 6.2.2 Status Window of ezManager

Status of CSW-B85 can be monitored by the [Status] button on ezManager. By using the [Refresh Every 1 Second] option in the window, the status will be automatically updated in every second.

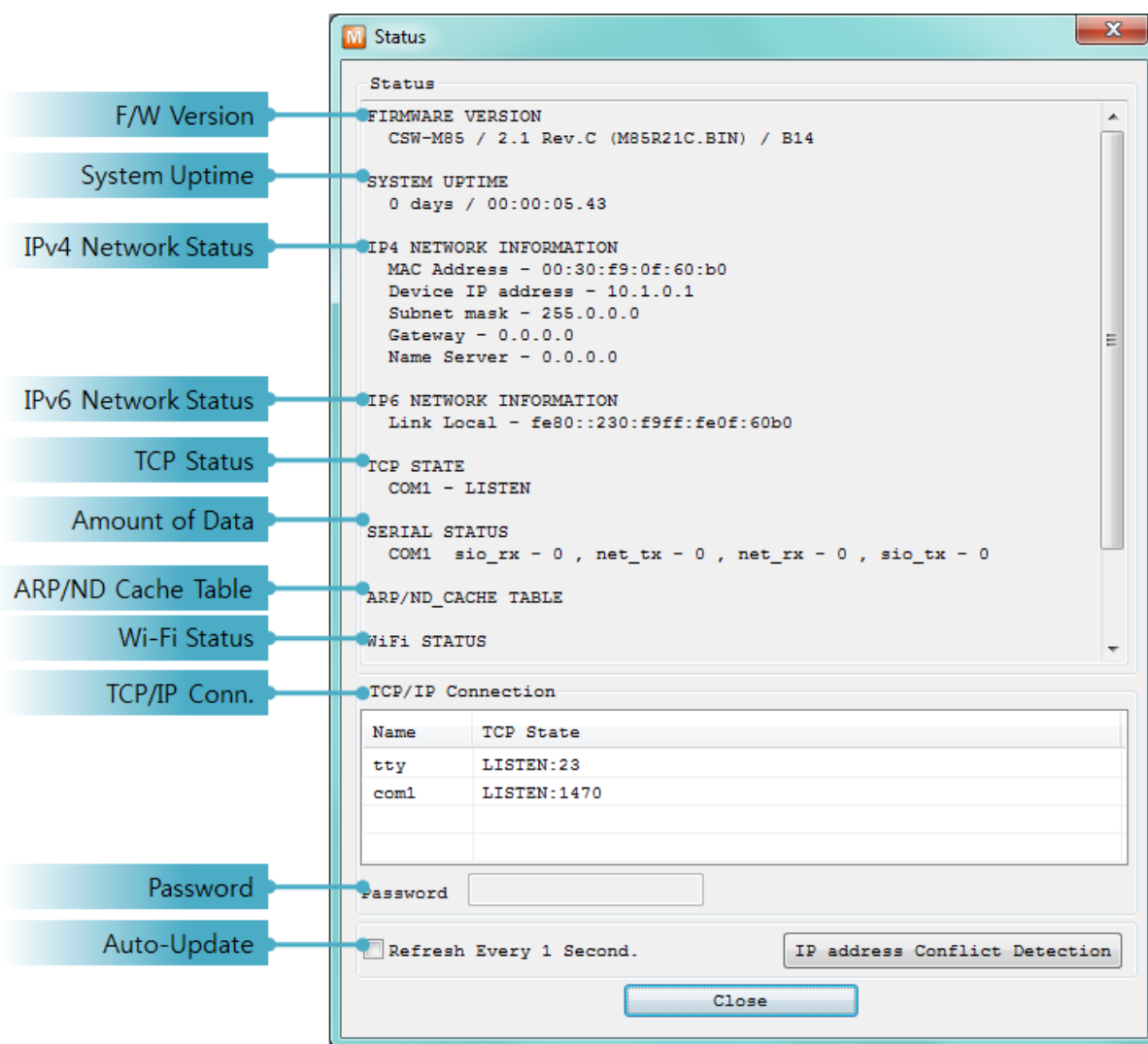

Figure 6-11 status window of ezManager

- FIRMWARE VERSION

The name of model and the version of firmware are displayed here.

- SYSTEM UPTIME

Amount of operating time since CSW-B85 has booted up is displayed.

- IP4 NETWORK INFORMATION

All information about related items with the IPv4 Address is shown here.

- IP6 NETWORK INFORMATION

All information about related items with the IPv6 Address is shown here. This item will be shown only when IPv6 is enabled.

- TCP STATE

TCP status of each port is shown in this section.

Message	Description
LISTEN	The session is waiting for TCP connection.
CLOSE	TCP connection is closed.
SYN_SENT	The session is sending "SYN" segment to a TCP server.
ESTABLISHED	TCP connection is established.
N/A	in UDP mode

Table 6-2 TCP STATE

- Amount of data

Amount of data in each buffer is displayed. The unit is byte.

Buffer	Description
sio_rx	The number of data received from the COM port
net_tx	The number of data sent to the remote host
net_rx	The number of data received from the remote host
sio_tx	The number of data sent to the COM port

Table 6-3 SERIAL STATUS

- ARP Table / ND Cache Table

This part shows ARP table on CSW-B85. When TCP connection is established or UDP data communication is performed, the information of IP and MAC address is automatically registered in the table. This information lasts for 1 minute so when 50 seconds has passed, CSW-B85 starts broadcasting the ARP packet in every second. If there is no response until the time is 0, the information is removed. Otherwise, the time is updated 60 seconds again.

In IPv6 case, it shows ND cache table. User can check by the ND cache messages. The messages are as follows.

State	Description
INCOMPLETE	This means the device is standing by after it sends the request message, Neighbor Solicitation, to MAC and link local address of an opponent in the initial communication.
REACHABLE	This means the device has information about the opponent after it sends Neighbor Solicitation, and receives Neighbor Advertisement.
STALE	The device will change into STALE state after some time later reaching REACHABLE.
DELAY	The device will change into DELAY state if there is no response to Neighbor Solicitation. In this case, CSW-B85 will not be able to communicate with the device.
PROBE	CSW-B85 will resend the request message to the device in DELAY state. CSW-B85 will keep sending Neighbor Solicitation until it replies.

Table 6-4 5 states of ND cache table

- Wi-Fi Status

Status of Wireless LAN Channel is displayed.

Item	Description
Channel	Current channel (Frequency band)
Link Speed	Maximum data rate of the link (Unit: Mbps)
RSSI	Received Signal Strength Indication (Unit: dBm)
RSNA	Current authentication algorithm (WEP, TKIP, CCMP)

Table 6-5 Wi-Fi status

- TCP/IP Connection

The same information with [TCP STATE] is displayed with an IP address and port number. A difference from [TCP STATE] is whether you can terminate TCP connection or not. When right clicking on a session, a small window will be popped up.

- Password

This text box is activated when CSW-B85 has a password. If you want to close TCP connection on [TCP/IP Connection] list, input the password first.

- Refresh Every 1 Second.

If this option is checked, ezManager sends queries in every second.

- IP Address Conflict Detection

By clicking this button, you can find devices which have the same IP address to yours on the network.

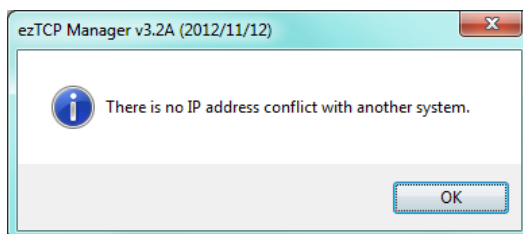

Figure 6-12 no conflict of IP addresses

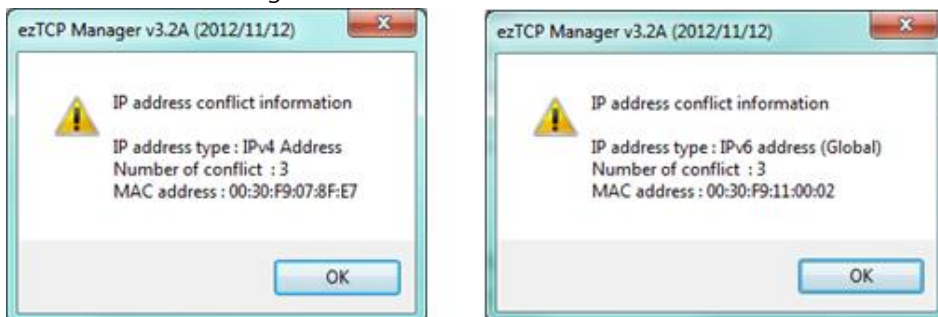

Figure 6-13 conflict of IP addresses



## 7 Additional Functions

### 7.1 Security

#### 7.1.1 Access Restriction (ezTCP Firewall)

On the [Option] tab of ezManager, you can set access restriction function with MAC and IP address.

- Allowed MAC Address

If this option has a valid value, the device with particular MAC address is only permitted to access.

- Allowed IP Address

This is for qualifying hosts with IP address or range of IP addresses. The range is defined by multiplying [IP address] and [Network Mask] in bit unit.

- Examples for IPv4

IP Address	Network Mask	Allowed IP Address Range
10.1.0.1	255.0.0.0	10.1.0.1 ~ 10.255.255.254
10.1.0.1	255.255.255.0	10.1.0.1 ~ 10.1.0.254
192.168.1.4	255.255.255.255	192.168.1.4

Table 7-1 examples of defining allowed IP range

- Apply to ezManager

[Apply to ezManager] is for applying above two restrictions to ezManager functions like [Search], [Read], [Write] and etc.

- Examples for IPv6

IPv6 Address	Prefix	Allowed IP Address Range
2001:DB8::100	64	2001:DB8::1 ~ 2001:DB8::FFFF:FFFF:FFFF:FFFF
2001:DB8::100	128	2001:DB8::100

Table 7-2 examples of defining allowed IPv6 range

#### 7.1.2 Setting Password

A password can be used to protect CSW-B85 from TELNET login or changing environmental parameters by unqualified hosts. The maximum length is 8 bytes of alphabet or number.

### 7.1.3 Using WEP

- AP settings  
Set parameters such as authentication mode (open / shared) and key length (64 / 128) on your AP. If you do not know how to set the parameters, refer to its manual or ask the manufacturer.
- CSW-B85 settings  
Input WEP Key, which is set on the AP, in [Shared Key] text box of [Security Settings] section on [WLAN] tab of ezManager.

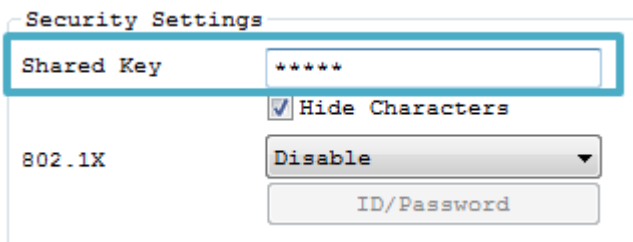

Figure 7-1 Shared Key settings

Type		Digit	Example
WEP64(64bits)	ASCII	5	abcde
	Hexadecimal	10	6162636465
WEP128(128bits)	ASCII	13	0123456789abc
	Hexadecimal	26	30313233343536373839616263

Table 7-3 WEP key settings

### 7.1.4 Using WPA-PSK

- AP settings  
Set the WPA-PSK or WPA2-PSK and related parameters on your AP. If you do not know how to set AP's parameters, refer to the manual or ask the manufacturer.
- CSW-B85 settings  
Input WPA-PSK Key, which is set on the AP, in [Shared Key] text box of [Security Settings] section on [WLAN] tab of ezManager. (See the Figure 7-1 Shared Key settings)

*The length of Key for WPA-PSK should be 8 ~ 63 characters.*

### 7.1.5 Using WPA-Enterprise

- Configuration of the Access Point  
Set WPA-Enterprise for authentication and radius server to communicate. If you do not know how to set AP's parameters, refer to the manual or ask the manufacturer.
- Configuration of the product  
Select one of authentication protocols on 802.1X item in the Security Settings.

Protocol	required configurations
EAP-TLS	ID of radius server account, client certificate
EAP-TTLS	ID and passphrase of radius server account
PEAP	ID and passphrase of radius server account

Table 7-4 802.1X item

**Caution:** Maximum length is restricted to 32Bytes for ID and 16Bytes for password.

- How to use EAP-TLS  
In the case of EAP-TLS, a certificate is needed to save by ezManager.  
The procedures are as follows:
  - ① Configure the ID of radius server account
  - ② Check the [Advanced Menu] option and click the [Certificate] button

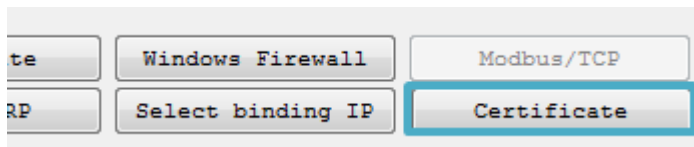

Figure 7-2 Certificate button

- ③ Save the client certificate made by radius server

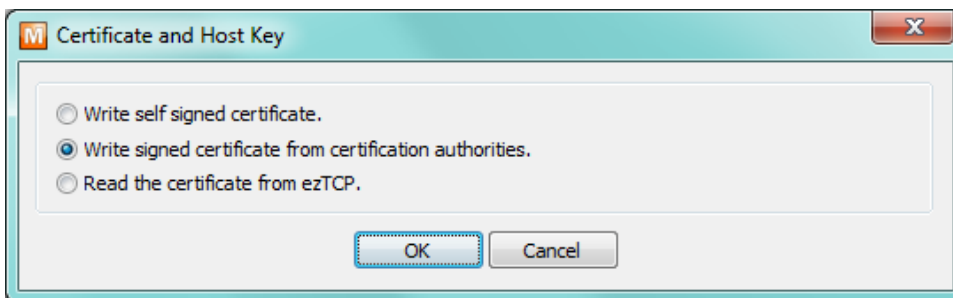

Figure 7-3 saving client certification

- ④ Input password for the certificate
- ⑤ Check the information of the certificate

### 7.1.6 Advanced Settings

You can configure advanced settings for WLAN. We recommend using the default values if you do not have any problem with it.

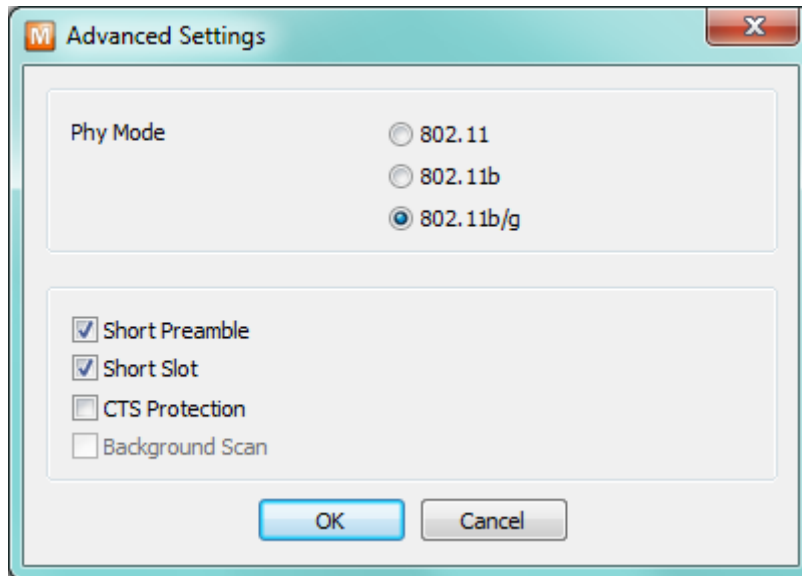

Figure 7-4 Advanced Settings

- PHY Mode
 

You have three options for PHY mode: [802.11], [802.11b] and [802.11b/g].
- Short Preamble
 

Under a good condition of WLAN environment you can expect a slight improvement of performance by enabling this option. Otherwise, it is better to disable this option.
- Short Slot
 

Using this option, you can expect some improvement in WLAN performances. If you are in bad condition of WLAN environment, you had better to disable this option.
- CTS Protection
 

Using this option, you can expect some improvement in WLAN performances under WLAN environment in both 802.11b and 11g devices are used at the same time.

## 7.2 Option Tab Functions

### 7.2.1 Notify IPv4 Change

CSW-B85 can be a TCP server even though its IPv4 address is automatically assigned. Using [Notify IP Change] function, CSW-B85 sends its IPv4 address to the specific server. It is offered in 3 types of services, DDNS, TCP and UDP.

- Dynamic Domain Name Service (DDNS)

CSW-B85 supports DDNS service offered by DynDNS. Therefore, you have to make an account and create host names at the DynDNS website before you use.

☞ **All about service usage of an account could be changed according to the policy of DynDNS.**

☞ **Homepage of DynDNS: <http://dyn.com/dns/>**

Figure 7-5 setting DDNS

- ① Select the [DDNS(dyndns.org)]
- ② 40,320 is a fixed value
- ③ Input the ID of DDNS account
- ④ Input the password of the account
- ⑤ Input a host name which you create on your account

- TCP/UDP

In case you have your own server and want to manage the information about changed IP addresses, you are allowed to use TCP/UDP. Not only can you set the [Interval], but also use both ASCII and hexadecimal in [Data Type].

☞ **Refer to the [IP Change Notification] document on our website for details.**

## 7.2.2 Sending MAC Address

[Sending MAC Address] is a function to send MAC address to the remote host right after a connection. By using this function, a server can identify multiple devices with the information.

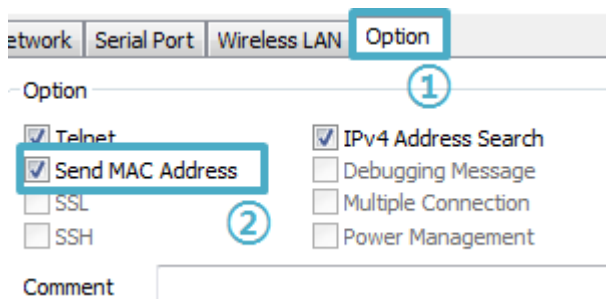

Figure 7-6 setting of Sending MAC Address function

- ① Move to the [Option] tab
- ② Check the [Send MAC Address] option

☞ ***Refer to the [Sending MAC Address Function] document on our website for details.***

### 7.3 Serial Port Tab Functions

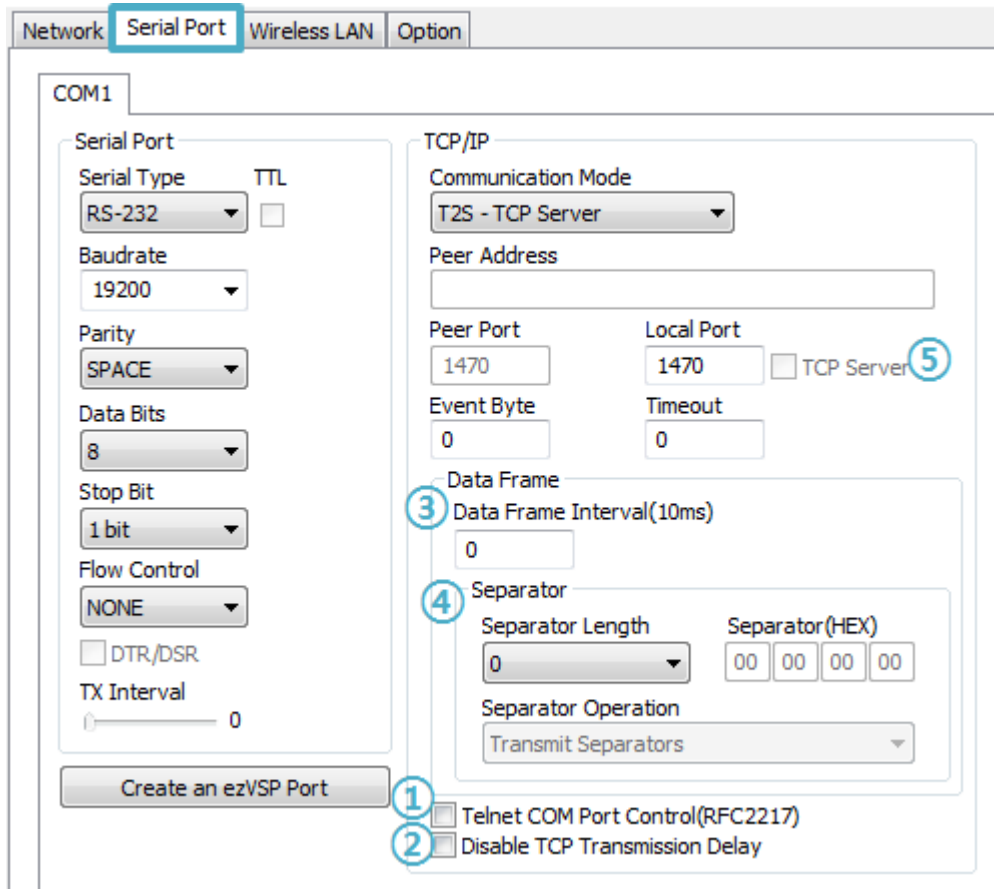

Figure 7-7 setting of TELNET COM Port Control option

#### 7.3.1 TELNET COM port Control Option (RFC 2217) - ①

This option is for sending and receiving serial port states between two devices. You can send and receive control signals such as RTS/CTS when the states are changed.

*☞ Refer to the [TELNET COM Port Control Option] document on our website for details.*

#### 7.3.2 Disable TCP Transmission Delay - ②

If you use this option, CSW-B85 sends the data from the serial port to WLAN as quickly as possible.

### 7.3.3 Data Frame Interval - ③

Before sending data from the serial port to WLAN, CSW-B85 gathers data in the buffer. If there is no data during the time configured in the [Data Frame Interval], it will send data to the network. In case the value is set to 0, data will be sent immediately. The unit is 10ms and this is operated more accurately by checking [Disable TCP Transmission Delay] option. Setting this value to over 11 is recommended.

### 7.3.4 Separator - ④

Using this function, you can control the length of network packets by specific characters.

separator	options
Length	select the length between 0 ~ 4 bytes
Operation	Transmit Separators without additional bytes
	Transmit Separators + 1 byte
	Transmit Separators + 2 bytes

Table 7-5 separator

### 7.3.5 TCP Server / Client mode - ⑤

This mode is available on TCP client mode only. In this mode, you do not need to change the mode for switching active or passive TCP connection. Note that the [Event Byte] option should be set to more than 1.

☞ *Refer to the [TCP Server/Client mode] document on our website for details.*



## 7.4 Additional Functions

### 7.4.1 Wireless RSSI(Received Signal Strength Indication) function

CSW-B85 indicates 4 levels of Received Signal Strength Indication (RSSI), measured from product side by LEDs.

- Using LINK Quality Indication  
Move the Jumper of J2 to S-N position.

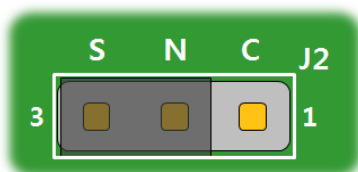

Figure 7-8 Wireless RSSI function

Keeping the S-N position, CSW-B85 indicates the RSSI by using 4 LED indicators which are listed on the table below.

Division	TXD	RXD	LINK	STS
RSSI < -70dBm	OFF	OFF	OFF	ON
-70dBm ≤ RSSI < -60dBm	OFF	OFF	ON	ON
-60dBm ≤ RSSI < -50dBm	OFF	ON	ON	ON
-50dBm ≤ RSSI	ON	ON	ON	ON

Table 7-6 4 states of Wireless RSSI function

☞ **Higher values of RSSI represent higher qualities of the wireless signal.**

### 7.4.2 Factory Reset

It is a function physically initializes all the setting.

- Using Factory Reset

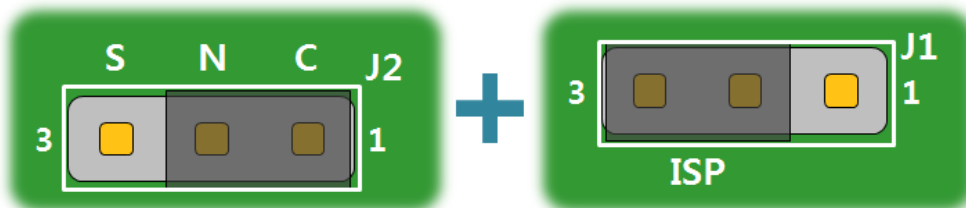

Figure 7-9 factory reset

- ① Connect pin #2-3 of J2(N-C).
- ② Connect pin #1-2 of J1(ISP).
- ③ Factory Reset will be automatically implemented to default values.
- ④ Remove the both jumper of J2 and J1 connection.
- ⑤ Reboot.

You can save a setting to user-defined ENV region and use it as default values by the factory reset. However, if you do not use the region, Factory Reset uses a factory default by manufacturer as its default values.

- Setting custom default values

- ① Change the mode to Serial Configuration mode
- ② Save custom default values by ezManager or serial configuration commands
- ③ Input the command below without rebooting.

b	<SPACE>	3c5a	<CR>
---	---------	------	------

- ④ After step ③, current values in the SRAM is saved in user-defined ENV region and the values will be always used for Factory Reset.

## 8 Checklist in Trouble

When you are in trouble with CSW-B85, make sure all the following first.

### 8.1 Searching problem with ezManager

- Confirming configuration utility

CSW-B85 should be configured by ezManager.

- Stopping Firewall operation

A firewall on personal computer or network can block broadcast packets. Stop all the firewalls before searching CSW-B85

☞ ***Most of vaccine applications have firewall functions so it can cause some trouble to search CSW-B85. Stop these programs before searching.***

- Stable supply of the power

Check if the power is supplied continually.

- Connection with the wireless network

Check if the wireless link is established. After confirming that the status of LINK LED is ON, check the list of wireless LAN devices on the management page of the AP.

☞ ***After booting up, establishing a wireless link could take some time (a few dozens of seconds) according to the network condition.***

- Connection with the network

Make sure that the network connection between the PC and AP including Ethernet cable. In this step, we recommend you to connect the AP with your PC directly or in the same network hub.

- Checking options of restriction

While this product operating in Serial Communication mode, you are not able to search via network. Please change the mode to normal mode or use Soft AP function.

## 8.2 Connection Problem over TCP/IP

- Connection with the wireless network

Check if the wireless link is fine.

- Checking parameters related with TCP/IP

When CSW-B85 has a private IP address, an IP address of a PC and B85 needs to be on the same network. Check if the IP address and local port number are correct. In the case of a fixed IP address related items such as subnet mask, gateway IP address and DNS IP address should be configured.

TCP Server side	TCP Client side
Local IP Address, Local Port, Subnet Mask, Gateway IP Address, DNS IP Address, DDNS option, and etc.	Local IP Address, Peer Address, Peer Port, Subnet Mask, Gateway IP Address, DNS IP Address, and etc.

Table 8-1 major parameters related with TCP/IP

- PING Test

Confirm the connection over the network by PING test. If the CSW-B85 doesn't send any reply from the request, check the network environment.

- Network Firewall

In the case of networks which need strong security, the access may be denied by their firewall. Under this circumstance, ask the network administrator to release ports which will be used. (Ex: TCP 1470, UDP 50005)

- Operation Mode

TCP connection will not be established when CSW-B85 is operating in the ISP or Serial Configuration mode.

- Communication Mode

To make TCP connection, both a server and client should exist. If there are only servers or clients, TCP connection cannot be established.

- ezTCP Firewall

When you set the ezTCP firewall with MAC and IP address, all hosts cannot be reachable except for the hosts have the allowed MAC and IP address. Inactivate the option or check the setting is correct for allowing specific hosts to access.

- Checking the TCP status

Basically, TCP is a protocol connected one to one. Because of this, if a device is TCP on-line state, other requests are denied. If you are in this situation, check the network status by connecting on TELNET or using ezManager.

### 8.3 Data Communication Problem on the Serial Port

- Connection of Pins

Check if the connection of each pin is right. Pin assignment is listed on the chapter 1.6.1. Using a cable, you have to choose the right type of cable which is suitable for the device.

☞ ***You must connect the Ground pin to your device when using RS422 or RS485 as well as RS232.***

- Setting parameters

Check if all the serial port parameters like Baud Rate, Data bit, Stop bit and Parity are properly set.

☞ ***Please contact us if you have any questions about above steps or our products.***

## 9 Related Materials

### 9.1 Documents

You can find each document on our web site or included CD in your package.

- Datasheet
- CE certificate
- Declaration of RoHS Compliance

### 9.2 Applications for a Smart Phone

- ezManager(for iOS)
- ezManager(for Android)
- TCP/IP Console(for iOS)
- TCP Client(for Android)

## 10 Technical Support and Warranty

### 10.1 Technical Support

If you have any question regarding operation of the product, visit Customer Support FAQ corner and the message board on Sollae Systems' web site or send us an email at the following address:

- E-mail: [support@eztcp.com](mailto:support@eztcp.com)
- Website Address for Customer Support: <http://www.eztcp.com/en/support/>

### 10.2 Warranty

#### 10.2.1 Refund

Upon the customer's request to refund the product within two weeks after purchase, Sollae Systems will refund the product.

#### 10.2.2 Free Repair Services

For product failures occurring within two years after purchase, Sollae Systems provides free repair services or exchange the product. However, if the product failure is due to user's fault, repair service fees will be charged or the product will be replaced at user's expense.

#### 10.2.3 Charged Repair Services

For product failures occurring after the warranty period (two years) or resulting from user's fault, repair service fees will be charged and the product will be replaced at user's expense.

# 11 Precaution and Exemption from Liability

## 11.1 Precaution

- Sollae Systems is not responsible for product failures occurring due to user's alteration of the product.
- Specifications of the product are subject to change without prior notice for performance improvement.
- Sollae Systems does not guarantee successful operation of the product if the product was used under conditions deviating from the product specifications.
- Reverse engineering of firmware and applications provided by Sollae Systems is prohibited.
- Use of firmware and applications provided by Sollae Systems for purposes other than those for which they were designed is prohibited.
- Do not use the product in an extremely cold or hot place or in a place where vibration is severe.
- Do not use the product in an environment in which humidity is high or a lot of oil exists.
- Do not use the product where there is caustic or combustible gas.
- Sollae Systems does not guarantee normal operation of the product under the conditions a lot of noise exists.
- Do not use the product for a purpose that requires exceptional quality and reliability relating to user's injuries or accidents – aerospace, aviation, health care, nuclear power, transportation, and safety purposes.
- Sollae Systems is not responsible for any accident or damage occurring while using the product.



## 11.2 Exemption from Liability

### 11.2.1 English version

In no event shall Sollae Systems Co., Ltd. and its distributors be liable for any damages whatsoever (including, without limitation, damages for loss of profit, operating cost for commercial interruption, loss of information, or any other financial loss) from the use or inability to use the CSW-B85 even if Sollae Systems Co., Ltd. or its distributors have been informed of such damages.

The CSW-B85 is not designed and not authorized for use in military applications, in nuclear applications, in airport applications or for use in applications involving explosives, or in medical applications, or for use in security alarm, or for use in a fire alarm, or in applications involving elevators, or in embedded applications in vehicles such as but not limited to cars, planes, trucks, boats, aircraft, helicopters, etc..

In the same way, the CSW-B85 is not designed, or intended, or authorized to test, develop, or be built into applications where failure could create a dangerous situation that may result in financial losses, damage to property, personal injury, or the death of people or animals. If you use the CSW-B85 voluntarily or involuntarily for such unauthorized applications, you agree to subtract Sollae Systems Co., Ltd. and its distributors from all liability for any claim for compensation.

Sollae Systems Co., Ltd. and its distributors entire liability and your exclusive remedy shall be Sollae Systems Co., Ltd. and its distributors option for the return of the price paid for, or repair, or replacement of the CSW-B85.

Sollae Systems Co., Ltd. and its distributors disclaim all other warranties, either expressed or implied, including, but not limited to, the implied warranties of merchantability and fitness for a particular purpose, with respect to the CSW-B85 including accompanying written material, hardware and firmware.

## 11.2.2 French version

- Documentation

La documentation du CSW-B85 est conçue avec la plus grande attention. Tous les efforts ont été mis en œuvre pour éviter les anomalies. Toutefois, nous ne pouvons garantir que cette documentation soit à 100% exempt de toute erreur. Les informations présentes dans cette documentation sont données à titre indicatif. Les caractéristiques techniques peuvent changer à tout moment sans aucun préavis dans le but d'améliorer la qualité et les possibilités des produits.

- Copyright et appellations commerciales

Toutes les marques, les procédés, les références et les appellations commerciales des produits cités dans la documentation appartiennent à leur propriétaire et Fabricant respectif.

- Conditions d'utilisations et limite de responsabilité

En aucun cas Sollae Systems Co., Ltd. ou un de ses distributeurs ne pourra être tenu responsable de dommages quels qu'ils soient (intégrant, mais sans limitation, les dommages pour perte de bénéfice commercial, interruption d'exploitation commerciale, perte d'informations et de données à caractère commercial ou de toute autre perte financière) provenant de l'utilisation ou de l'incapacité à pouvoir utiliser le CSW-B85, même si Sollae Systems Co., Ltd. ou un de ses distributeurs a été informé de la possibilité de tels dommages.

Le CSW-B85 est exclusivement prévu pour un usage en intérieur, dans un environnement sec, tempéré (+10 °C à +40°C) et non poussiéreux. Le CSW-B85 n'est pas prévu, ni autorisé pour être utilisé en extérieur, ni de façon embarquée dans des engins mobiles de quelque nature que ce soit (voiture, camion, train, avion, etc...), ni en milieu explosif, ni dans des enceintes nucléaires, ni dans des ascenseurs, ni dans des aéroports, ni dans des enceintes hospitaliers, ni pour des applications à caractère médical, ni dans des dispositifs de détection et d'alerte anti-intrusion, ni dans des dispositifs de détection et d'alerte anti-incendie, ni dans des dispositifs d'alarme GTC, ni pour des applications militaires.

De même, le CSW-B85 n'est pas conçu, ni destiné, ni autorisé pour expérimenter, développer ou être intégré au sein d'applications dans lesquelles une défaillance de celui-ci pourrait créer une situation dangereuse pouvant entraîner des pertes financières, des dégâts matériel, des blessures corporelles ou la mort de personnes ou d'animaux. Si vous utilisez le CSW-B85 volontairement ou involontairement pour de telles applications non

autorisées, vous vous engagez à soustraire Sollae Systems Co., Ltd. et ses distributeurs de toute responsabilité et de toute demande de dédommagement.

En cas de litige, l'entière responsabilité de Sollae Systems Co., Ltd. et de ses distributeurs vis-à-vis de votre recours durant la période de garantie se limitera exclusivement selon le choix de Sollae Systems Co., Ltd. et de ses distributeurs au remboursement de votre produit ou de sa réparation ou de son échange. Sollae Systems Co., Ltd. et ses distributeurs démentent toutes autres garanties, exprimées ou implicites.

Tous les CSW-B85 sont testés avant expédition. Toute utilisation en dehors des spécifications et limites indiquées dans cette documentation ainsi que les court-circuit, les chocs, les utilisations non autorisées, pourront affecter la fiabilité, créer des dysfonctionnements et/ou la destruction du CSW-B85 sans que la responsabilité de Sollae Systems Co., Ltd. et de ses distributeurs ne puissent être mise en cause, ni que le CSW-B85 puisse être échangé au titre de la garantie.

- Rappel sur l'évacuation des équipements électroniques usagés

Le symbole de la poubelle barré présent sur le CSW-B85 indique que vous ne pouvez pas vous débarrasser de ce dernier de la même façon que vos déchets courants. Au contraire, vous êtes responsable de l'évacuation du CSW-B85 lorsqu'il arrive en fin de vie (ou qu'il est hors d'usage) et à cet effet, vous êtes tenu de le remettre à un point de collecte agréé pour le recyclage des équipements électriques et électroniques usagés. Le tri, l'évacuation et le recyclage séparés de vos équipements usagés permettent de préserver les ressources naturelles et de s'assurer que ces équipements sont recyclés dans le respect de la santé humaine et de l'environnement. Pour plus d'informations sur les lieux de collecte des équipements électroniques usagés, contacter votre mairie ou votre service local de traitement des déchets.

## 12 Revision History

Date	Version	Description	Author
2012.06.07	1.1	○ Initial release	Roy LEE
2012.09.11	1.2	○ Add IPv6 related contents ○ Add descriptions of Soft AP function ○ Add descriptions of WPA-Enterprise ○ Modify descriptions about WEP, WPA-PSK ○ Change position of caption "Table" ○ Modify descriptions of 2.1 Wireless LAN Overview ○ Correct some errors and expressions	Roy LEE
2012.09.26	1.3	○ Modify descriptions of 4.2. Changing modes ○ Modify descriptions of Factory Reset function ○ Correct some errors and expressions	Roy LEE
2012.10.25	1.4	○ Add a clause about serial port parameters ○ Add description of WEB configuration ○ Modify configuration of WEP and WPA-PSK ○ Modify some document styles ○ Correct some errors and expressions	Roy LEE
2012.12.28	1.5	○ Modify description of Soft AP function ○ Add an example of TCP Server / Client mode ○ Update some figures ○ Add a description about test condition for certificate. ○ Add descriptions of ND cache table ○ Add a figure of IP address confliction ○ Correct some expressions	Roy LEE
2013.02.26	1.7	○ Add a notification about connecting ground pins ○ Add a notification about mobile applications ○ Correct some errors and expressions	Roy LEE
2013.05.16	1.8	○ Add a contents about sd command in TELNET ○ Modify descriptions of setting WEP key ○ Add Related Materials chapter ○ Add Exemption from Liability chapter ○ Correct some errors and expressions	Roy LEE
2013.12.18	1.9	○ Correct some errors and expressions	Roy LEE
2014.06.23	2.0	○ Improve description of 2.2.1 (using Soft AP method)	Roy LEE

2014.10.23	2.1	<ul style="list-style-type: none"> <li>○ Modify description of Factory Reset</li> <li>○ Add "exit" command for TELNET</li> <li>○ Change figures 5-1 ~ 5-4</li> <li>○ Add TCP/IP Console for iOS on the application list</li> <li>○ Add a note about max size of ID/PW for WPA Enterprise</li> <li>○ Correct some errors and expressions</li> </ul>	Roy LEE
2015.05.27	2.2	<ul style="list-style-type: none"> <li>○ Improve description about chapter 2.2 (RS232 connection with PC)</li> <li>○ Add a note about entering serial configuration mode</li> <li>○ Modify table 1-8: entering serial configuration mode</li> </ul>	Roy LEE
2016.04.07	2.3	<ul style="list-style-type: none"> <li>○ Add a description about TELNET login</li> <li>○ Correct some errors and expressions</li> </ul>	Roy LEE